

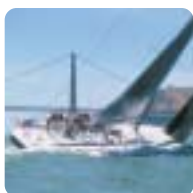

Guide to Composites

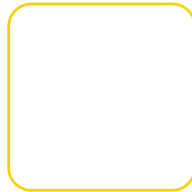
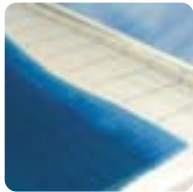

Contents

Introduction	1
Composite Theory	1
Polymer Matrix Composites	1
Loading	3
Comparison with Other Structural Materials	4
Resin Systems	8
Introduction	8
Resin Types	9
Polyester Resins	10
Vinylester Resins	13
Epoxy Resins	14
Gelation, Curing and Post-Curing	16
Comparison of Resin Properties	16
Adhesive Properties	16
Mechanical Properties	17
Micro-Cracking	18
Fatigue Resistance	19
Degradation from Water Ingress	19
Osmosis	20
Resin Comparison Summary	21
Other Resin Systems Used in Composites	21
Reinforcements	23
Properties of Reinforcing Fibres & Finishes	23
Basic Properties of Fibres	24
Laminate Mechanical Properties	25
Laminate Impact Strength	25
Comparative Fibre Cost	26

Fibre Types	27
Fibre Finishes	32
Fabric Types and Constructions	33
Unidirectional Fabrics	33
0/90° Fabrics	34
Woven Fabrics	34
Stitched 0/90° Fabrics	37
Hybrid Fabrics	37
Multiaxial Fabrics	38
Other Fabrics	40
Core Materials	41
<hr/>	
Introduction	41
Core Types	41
Foam Cores	41
Honeycombs	43
Wood	46
Other Core Materials	46
Comparison of Core Mechanical Properties	47
Manufacturing Processes	50
<hr/>	
Introduction	50
Comparison of Processes	50
Spray Lay-up	50
Wet lay-up/Hand Lay-up	51
Vacuum Bagging	53
Filament Winding	54
Pultrusion	55
Resin Transfer Moulding (RTM)	56
Other Infusion Processes - SCRIMP, RIFT, VARTM	57
Prepregs	58
Low Temperature Curing Prepregs	60
Resin Film Infusion (RFI)	61
Estimating Quantities of SP Formulated Products	62
Laminate Formulae	63
Imperial / Metric Conversion Tables for SP Products	64

SP Guide to Composites

Introduction

To fully appreciate the role and application of composite materials to a structure, an understanding is required of the component materials themselves and of the ways in which they can be processed. This guide looks at basic composite theory, properties of materials used and then the various processing techniques commonly found for the conversion of materials into finished structures.

Composite Theory

In its most basic form a composite material is one which is composed of at least two elements working together to produce material properties that are different to the properties of those elements on their own. In practice, most composites consist of a bulk material (the 'matrix'), and a reinforcement of some kind, added primarily to increase the strength and stiffness of the matrix. This reinforcement is usually in fibre form. Today, the most common man-made composites can be divided into three main groups:

Polymer Matrix Composites (PMC's) – These are the most common and will be discussed here. Also known as FRP - Fibre Reinforced Polymers (or Plastics) - these materials use a polymer-based resin as the matrix, and a variety of fibres such as glass, carbon and aramid as the reinforcement.

Metal Matrix Composites (MMC's) - Increasingly found in the automotive industry, these materials use a metal such as aluminium as the matrix, and reinforce it with fibres such as silicon carbide.

Ceramic Matrix Composites (CMC's) - Used in very high temperature environments, these materials use a ceramic as the matrix and reinforce it with short fibres, or whiskers such as those made from silicon carbide and boron nitride.

Polymer Matrix Composites

Resin systems such as epoxies and polyesters have limited use for the manufacture of structures on their own, since their mechanical properties are not very high when compared to, for example, most metals. However, they have desirable properties, most notably their ability to be easily formed into complex shapes.

Materials such as glass, aramid and boron have extremely high tensile and compressive strength but in 'solid form' these properties are not readily apparent. This is due to the fact that when stressed, random surface flaws will cause each material to crack and fail well below its theoretical 'breaking point'. To overcome this problem, the material is produced in fibre form, so that, although the same number of random flaws will occur, they will be restricted to a small number of fibres with the remainder exhibiting the material's theoretical strength. Therefore a bundle of fibres will reflect more accurately the optimum performance of the material. However, fibres alone can only exhibit tensile properties along the fibre's length, in the same way as fibres in a rope.

It is when the resin systems are combined with reinforcing fibres such as glass, carbon and aramid, that exceptional properties can be obtained. The resin matrix spreads the load applied to the composite between each of the individual fibres and also protects the fibres from damage caused by abrasion and impact. High strengths and stiffnesses, ease of moulding complex shapes, high environmental resistance all coupled with low densities, make the resultant composite superior to metals for many applications.

Since PMC's combine a resin system and reinforcing fibres, the properties of the resulting composite material will combine something of the properties of the resin on its own with that of the fibres on their own.

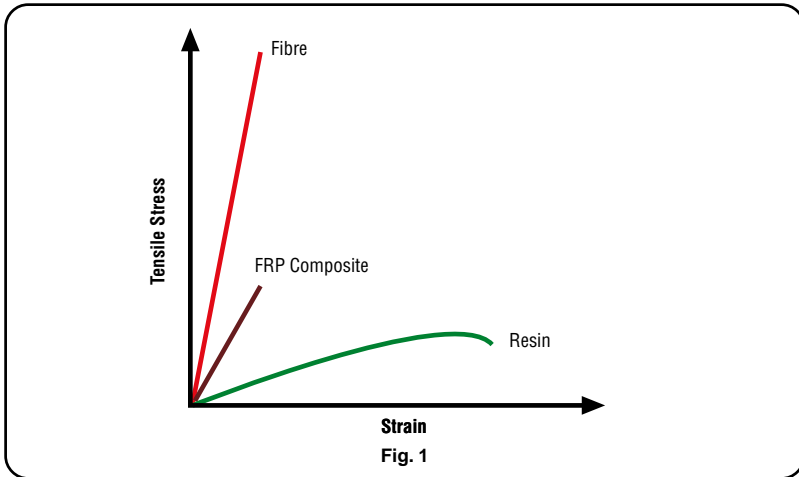

Overall, the properties of the composite are determined by:

- i) The properties of the fibre
- ii) The properties of the resin
- iii) The ratio of fibre to resin in the composite (Fibre Volume Fraction)
- iv) The geometry and orientation of the fibres in the composite

The first two will be dealt with in more detail later. The ratio of the fibre to resin derives largely from the manufacturing process used to combine resin with fibre, as will be described in the section on manufacturing processes. However, it is also influenced by the type of resin system used, and the form in which the fibres are incorporated. In general, since the mechanical properties of fibres are much higher than those of resins, the higher the fibre volume fraction the higher will be the mechanical properties of the resultant composite. In practice there are limits to this, since the fibres need to be fully coated in resin to be effective, and there will be an optimum packing of the generally circular cross-section fibres. In addition, the manufacturing process used to combine fibre with resin leads to varying amounts of imperfections and air inclusions. Typically, with a common hand lay-up process as widely used in the boat-building

industry, a limit for FVF is approximately 30-40%. With the higher quality, more sophisticated and precise processes used in the aerospace industry, FVF's approaching 70% can be successfully obtained.

The geometry of the fibres in a composite is also important since fibres have their highest mechanical properties along their lengths, rather than across their widths. This leads to the highly anisotropic properties of composites, where, unlike metals, the mechanical properties of the composite are likely to be very different when tested in different directions. This means that it is very important when considering the use of composites to understand at the design stage, both the magnitude and the direction of the applied loads. When correctly accounted for, these anisotropic properties can be very advantageous since it is only necessary to put material where loads will be applied, and thus redundant material is avoided.

It is also important to note that with metals the properties of the materials are largely determined by the material supplier, and the person who fabricates the materials into a finished structure can do almost nothing to change those 'in-built' properties. However, a composite material is formed at the same time as the structure is itself being fabricated. This means that the person who is making the structure is creating the properties of the resultant composite material, and so the manufacturing processes they use have an unusually critical part to play in determining the performance of the resultant structure.

Loading

There are four main direct loads that any material in a structure has to withstand: tension, compression, shear and flexure.

Tension

Fig. 2 shows a tensile load applied to a composite. The response of a composite to tensile loads is very dependent on the tensile stiffness and strength properties of the reinforcement fibres, since these are far higher than the resin system on its own.

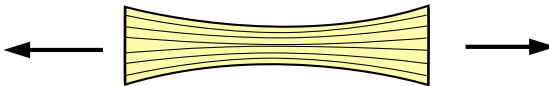

Fig. 2

Compression

Fig. 3 shows a composite under a compressive load. Here, the adhesive and stiffness properties of the resin system are crucial, as it is the role of the resin to maintain the fibres as straight columns and to prevent them from buckling.

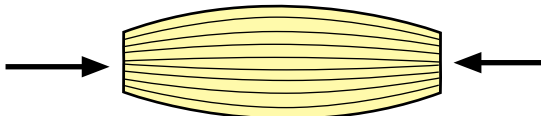

Fig. 3

Shear

Fig. 4 shows a composite experiencing a shear load. This load is trying to slide adjacent layers of fibres over each other. Under shear loads the resin plays the major role, transferring the stresses across the composite. For the composite to perform well under shear loads the resin element must not only exhibit good mechanical properties but must also have high adhesion to the reinforcement fibre. The interlaminar shear strength (ILSS) of a composite is often used to indicate this property in a multi-layer composite ('laminate').

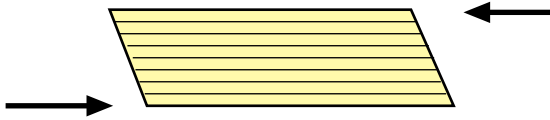

Fig. 4

Flexure

Flexural loads are really a combination of tensile, compression and shear loads. When loaded as shown, the upper face is put into compression, the lower face into tension and the central portion of the laminate experiences shear.

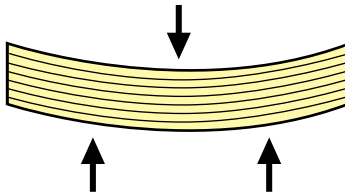
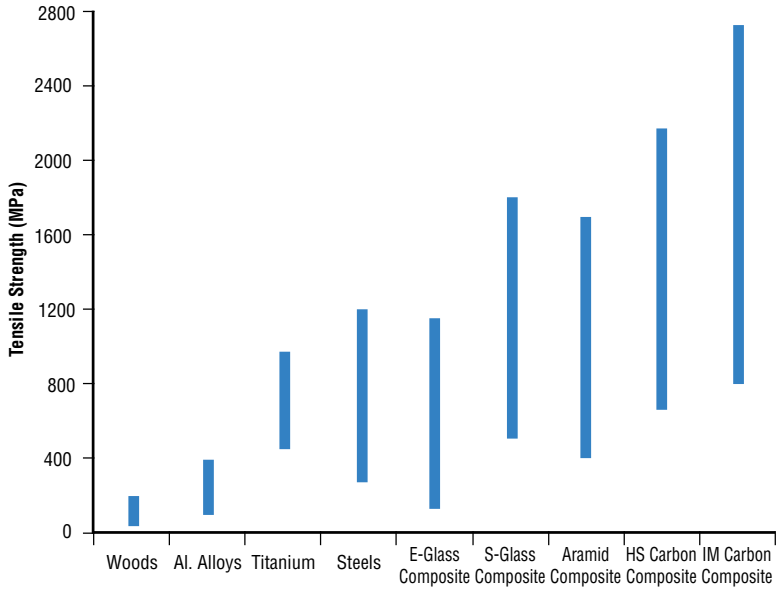

Fig. 5

Comparison with Other Structural Materials

Due to the factors described above, there is a very large range of mechanical properties that can be achieved with composite materials. Even when considering one fibre type on its own, the composite properties can vary by a factor of 10 with the range of fibre contents and orientations that are commonly achieved. The comparisons that follow therefore show a range of mechanical properties for the composite materials. The lowest properties for each material are associated with simple manufacturing processes and material forms (e.g. spray lay-up glass fibre), and the higher properties are associated with higher technology manufacture (e.g. autoclave moulding of unidirectional glass fibre prepreg), such as would be found in the aerospace industry.

For the other materials shown, a range of strength and stiffness (modulus) figures is also given to indicate the spread of properties associated with different alloys, for example.



Tensile Strength of Common Structural Materials

Fig. 6

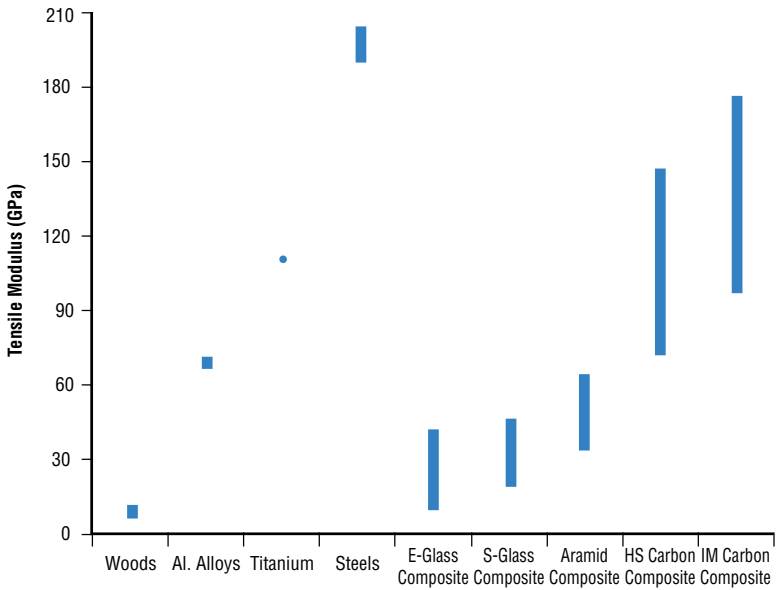

Tensile Modulus of Common Structural Materials

Fig. 7

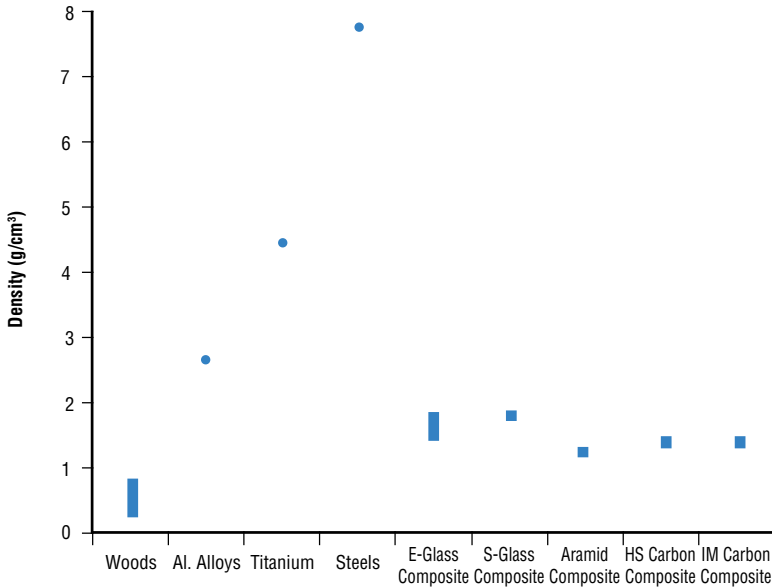

Densities of Common Structural Materials

Fig. 8

The above figures clearly show the range of properties that different composite materials can display. These properties can best be summed up as high strengths and stiffnesses combined with low densities. It is these properties that give rise to the characteristic high strength and stiffness to weight ratios that make composite structures ideal for so many applications. This is particularly true of applications which involve movement, such as cars, trains and aircraft, since lighter structures in such applications play a significant part in making these applications more efficient.

The strength and stiffness to weight ratio of composite materials can best be illustrated by the following graphs that plot 'specific' properties. These are simply the result of dividing the mechanical properties of a material by its density. Generally, the properties at the higher end of the ranges illustrated in the previous graphs are produced from the highest density variant of the material. The spread of specific properties shown in the following graphs takes this into account.

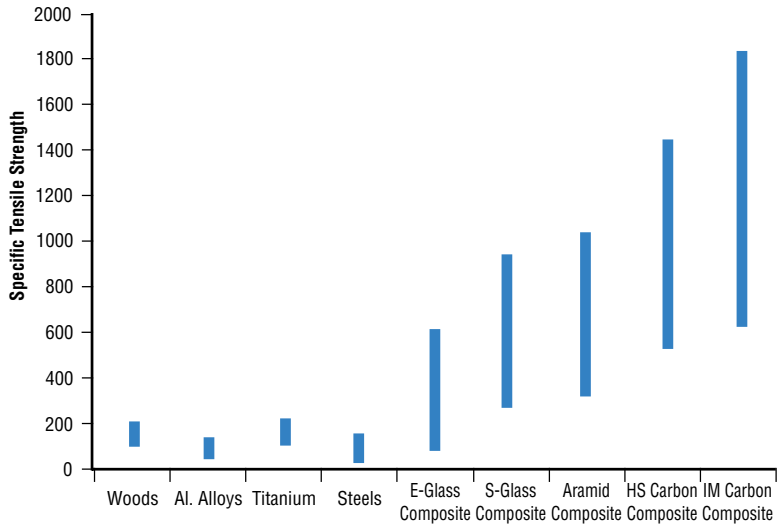

Specific Tensile Strength of Common Structural Materials

Fig. 9

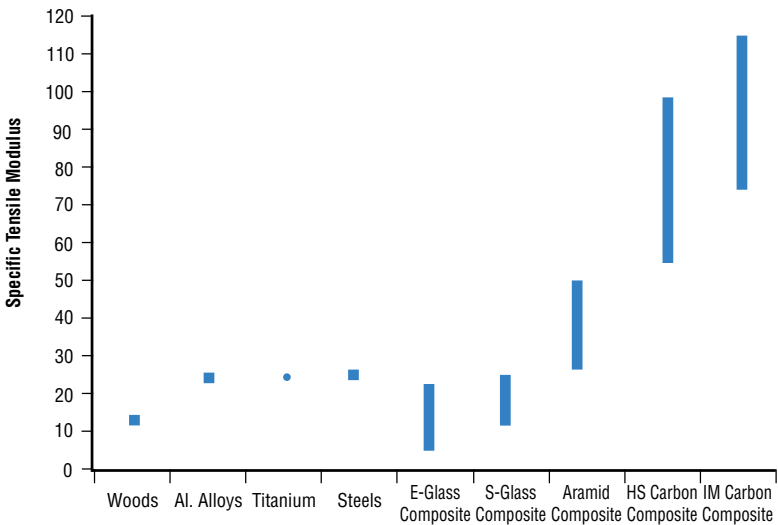

Specific Tensile Modulus of Common Structural Materials

Fig. 10

Further comparisons between laminates made from the different fibre types are given later in this guide in the section on 'Reinforcements'.

Resin Systems

Introduction

Any resin system for use in a composite material will require the following properties:

1. Good mechanical properties
2. Good adhesive properties
3. Good toughness properties
4. Good resistance to environmental degradation

Mechanical Properties of the Resin System

The figure below shows the stress / strain curve for an 'ideal' resin system. The curve for this resin shows high ultimate strength, high stiffness (indicated by the initial gradient) and a high strain to failure. This means that the resin is initially stiff but at the same time will not suffer from brittle failure.

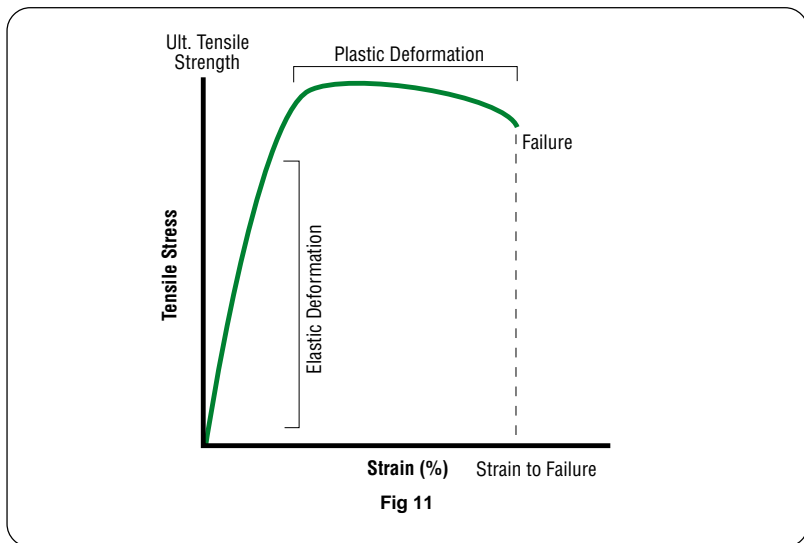

It should also be noted that when a composite is loaded in tension, for the full mechanical properties of the fibre component to be achieved, the resin must be able to deform to at least the same extent as the fibre. Fig. 12 gives the strain to failure for E-glass, S-glass, aramid and high-strength grade carbon fibres on their own (i.e. not in a composite form). Here it can be seen that, for example, the S-glass fibre, with an elongation to break of 5.3%, will require a resin with an elongation to break of at least this value to achieve maximum tensile properties.

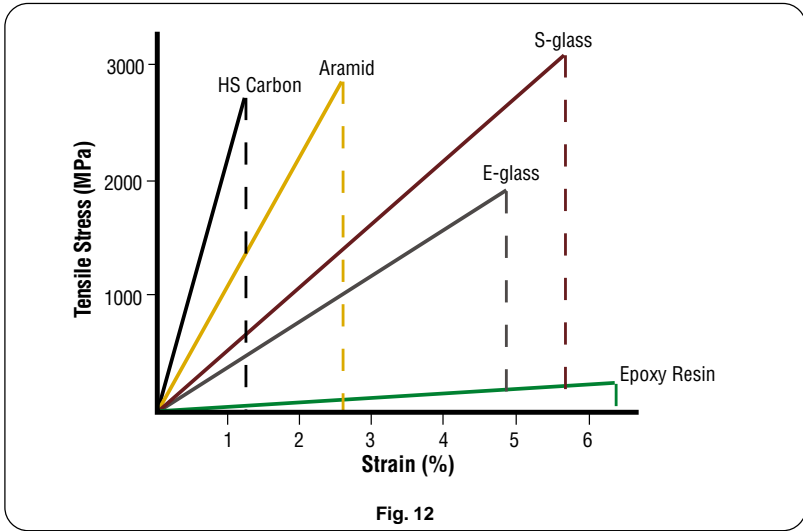

Adhesive Properties of the Resin System

High adhesion between resin and reinforcement fibres is necessary for any resin system. This will ensure that the loads are transferred efficiently and will prevent cracking or fibre / resin debonding when stressed.

Toughness Properties of the Resin System

Toughness is a measure of a material's resistance to crack propagation, but in a composite this can be hard to measure accurately. However, the stress / strain curve of the resin system on its own provides some indication of the material's toughness. Generally the more deformation the resin will accept before failure the tougher and more crack-resistant the material will be. Conversely, a resin system with a low strain to failure will tend to create a brittle composite, which cracks easily. It is important to match this property to the elongation of the fibre reinforcement.

Environmental Properties of the Resin System

Good resistance to the environment, water and other aggressive substances, together with an ability to withstand constant stress cycling, are properties essential to any resin system. These properties are particularly important for use in a marine environment.

Resin Types

The resins that are used in fibre reinforced composites are sometimes referred to as 'polymers'. All polymers exhibit an important common property in that they are composed of long chain-like molecules consisting of many simple repeating units. Man-made polymers are generally called 'synthetic resins' or simply 'resins'. Polymers can

be classified under two types, 'thermoplastic' and 'thermosetting', according to the effect of heat on their properties.

Thermoplastics, like metals, soften with heating and eventually melt, hardening again with cooling. This process of crossing the softening or melting point on the temperature scale can be repeated as often as desired without any appreciable effect on the material properties in either state. Typical thermoplastics include nylon, polypropylene and ABS, and these can be reinforced, although usually only with short, chopped fibres such as glass.

Thermosetting materials, or 'thermosets', are formed from a chemical reaction in situ, where the resin and hardener or resin and catalyst are mixed and then undergo a non-reversible chemical reaction to form a hard, infusible product. In some thermosets, such as phenolic resins, volatile substances are produced as by-products (a 'condensation' reaction). Other thermosetting resins such as polyester and epoxy cure by mechanisms that do not produce any volatile by products and thus are much easier to process ('addition' reactions). Once cured, thermosets will not become liquid again if heated, although above a certain temperature their mechanical properties will change significantly. This temperature is known as the Glass Transition Temperature (T_g), and varies widely according to the particular resin system used, its degree of cure and whether it was mixed correctly. Above the T_g, the molecular structure of the thermoset changes from that of a rigid crystalline polymer to a more flexible, amorphous polymer. This change is reversible on cooling back below the T_g. Above the T_g properties such as resin modulus (stiffness) drop sharply, and as a result the compressive and shear strength of the composite does too. Other properties such as water resistance and colour stability also reduce markedly above the resin's T_g.

Although there are many different types of resin in use in the composite industry, the majority of structural parts are made with three main types, namely polyester, vinylester and epoxy.

Polyester Resins

Polyester resins are the most widely used resin systems, particularly in the marine industry. By far the majority of dinghies, yachts and work-boats built in composites make use of this resin system.

Polyester resins such as these are of the 'unsaturated' type. Unsaturated polyester resin is a thermoset, capable of being cured from a liquid or solid state when subject to the right conditions. An unsaturated polyester differs from a saturated polyester such as Terylene™ which cannot be cured in this way. It is usual, however, to refer to unsaturated polyester resins as 'polyester resins', or simply as 'polyesters'.

In chemistry the reaction of a base with an acid produces a salt. Similarly, in organic chemistry the reaction of an alcohol with an organic acid produces an ester and water. By using special alcohols, such as a glycol, in a reaction with di-basic acids, a polyester and water will be produced. This reaction, together with the addition of compounds such as saturated di-basic acids and cross-linking monomers, forms the basic process of polyester manufacture. As a result there is a whole range of polyesters made from different acids, glycols and monomers, all having varying properties.

There are two principle types of polyester resin used as standard laminating systems in the composites industry. Orthophthalic polyester resin is the standard economic resin used by many people. Isophthalic polyester resin is now becoming the preferred material in industries such as marine where its superior water resistance is desirable.

Figure 13 shows the idealised chemical structure of a typical polyester. Note the positions of the ester groups (CO - O - C) and the reactive sites (C* = C*) within the molecular chain.

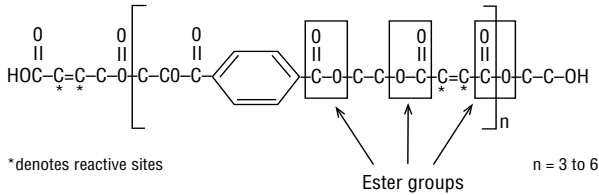

Idealised Chemical Structure of a Typical Isophthalic Polyester

Fig. 13

Most polyester resins are viscous, pale coloured liquids consisting of a solution of a polyester in a monomer which is usually styrene. The addition of styrene in amounts of up to 50% helps to make the resin easier to handle by reducing its viscosity. The styrene also performs the vital function of enabling the resin to cure from a liquid to a solid by 'cross-linking' the molecular chains of the polyester, without the evolution of any by-products. These resins can therefore be moulded without the use of pressure and are called 'contact' or 'low pressure' resins. Polyester resins have a limited storage life as they will set or 'gel' on their own over a long period of time. Often small quantities of inhibitor are added during the resin manufacture to slow this gelling action.

For use in moulding, a polyester resin requires the addition of several ancillary products. These products are generally:

- Catalyst
- Accelerator
- Additives: Thixotropic
Pigment
Filler
Chemical/fire resistance

A manufacturer may supply the resin in its basic form or with any of the above additives already included. Resins can be formulated to the moulder's requirements ready simply for the addition of the catalyst prior to moulding. As has been mentioned, given enough time an unsaturated polyester resin will set by itself. This rate of polymerisation is too slow for practical purposes and therefore catalysts and accelerators are used to achieve the polymerisation of the resin within a practical time period. Catalysts are added to the resin system shortly before use to initiate the polymerisation

reaction. The catalyst does not take part in the chemical reaction but simply activates the process. An accelerator is added to the catalysed resin to enable the reaction to proceed at workshop temperature and/or at a greater rate. Since accelerators have little influence on the resin in the absence of a catalyst they are sometimes added to the resin by the polyester manufacturer to create a 'pre-accelerated' resin.

The molecular chains of the polyester can be represented as follows, where 'B' indicates the reactive sites in the molecule.

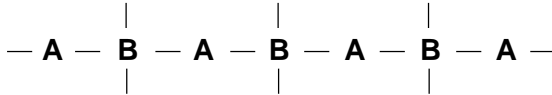

Schematic Representation of Polyester Resin (Uncured)

Fig. 14

With the addition of styrene 'S', and in the presence of a catalyst, the styrene cross-links the polymer chains at each of the reactive sites to form a highly complex three-dimensional network as follows:

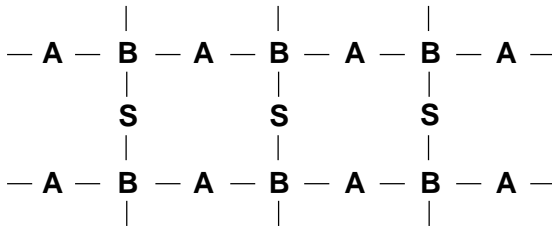

Schematic Representation of Polyester Resin (Cured)

Fig. 15

The polyester resin is then said to be 'cured'. It is now a chemically resistant (and usually) hard solid. The cross-linking or curing process is called 'polymerisation'. It is a non-reversible chemical reaction. The 'side-by-side' nature of this cross-linking of the molecular chains tends to mean that polyester laminates suffer from brittleness when shock loadings are applied.

Great care is needed in the preparation of the resin mix prior to moulding. The resin and any additives must be carefully stirred to disperse all the components evenly before the catalyst is added. This stirring must be thorough and careful as any air introduced into the resin mix affects the quality of the final moulding. This is especially so when laminating with layers of reinforcing materials as air bubbles can be formed within the resultant laminate which can weaken the structure. It is also important to add the accelerator and catalyst in carefully measured amounts to control the polymerisation reaction to give the best material properties. Too much catalyst will cause too rapid a gelation time, whereas too little catalyst will result in under-cure.

Colouring of the resin mix can be carried out with pigments. The choice of a suitable pigment material, even though only added at about 3% resin weight, must be carefully

considered as it is easy to affect the curing reaction and degrade the final laminate by use of unsuitable pigments.

Filler materials are used extensively with polyester resins for a variety of reasons including:

- To reduce the cost of the moulding
- To facilitate the moulding process
- To impart specific properties to the moulding

Fillers are often added in quantities up to 50% of the resin weight although such addition levels will affect the flexural and tensile strength of the laminate. The use of fillers can be beneficial in the laminating or casting of thick components where otherwise considerable exothermic heating can occur. Addition of certain fillers can also contribute to increasing the fire-resistance of the laminate.

Vinylester Resins

Vinylester resins are similar in their molecular structure to polyesters, but differ primarily in the location of their reactive sites, these being positioned only at the ends of the molecular chains. As the whole length of the molecular chain is available to absorb shock loadings this makes vinylester resins tougher and more resilient than polyesters. The vinylester molecule also features fewer ester groups. These ester groups are susceptible to water degradation by hydrolysis which means that vinylesters exhibit better resistance to water and many other chemicals than their polyester counterparts, and are frequently found in applications such as pipelines and chemical storage tanks.

The figure below shows the idealised chemical structure of a typical vinylester. Note the positions of the ester groups and the reactive sites ($C^* = C^*$) within the molecular chain.

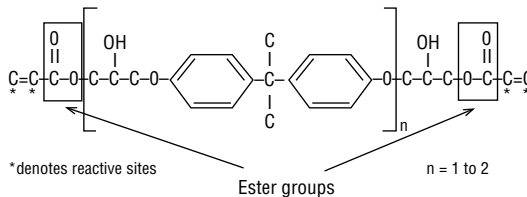

Idealised Chemical Structure of a Typical Epoxy Based Vinylester

Fig. 16

The molecular chains of vinylester, represented below, can be compared to the schematic representation of polyester shown previously where the difference in the location of the reactive sites can be clearly seen:

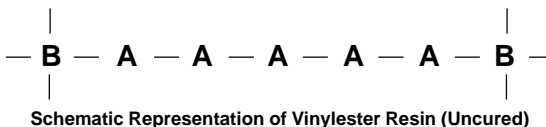
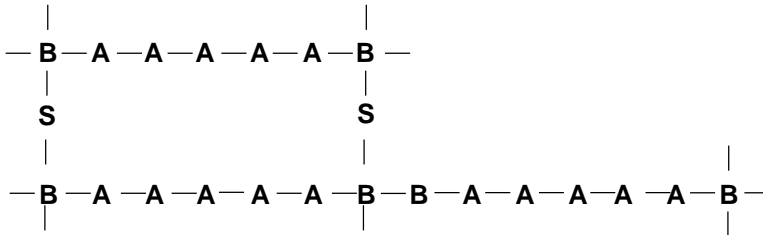

Fig. 17

With the reduced number of ester groups in a vinyl ester when compared to a polyester, the resin is less prone to damage by hydrolysis. The material is therefore sometimes used as a barrier or 'skin' coat for a polyester laminate that is to be immersed in water, such as in a boat hull. The cured molecular structure of the vinyl ester also means that it tends to be tougher than a polyester, although to really achieve these properties the resin usually needs to have an elevated temperature postcure.



Schematic Representation of Vinyl ester Resin (Cured)

Fig. 18

Epoxy Resins

The large family of epoxy resins represent some of the highest performance resins of those available at this time. Epoxies generally out-perform most other resin types in terms of mechanical properties and resistance to environmental degradation, which leads to their almost exclusive use in aircraft components. As a laminating resin their increased adhesive properties and resistance to water degradation make these resins ideal for use in applications such as boat building. Here epoxies are widely used as a primary construction material for high-performance boats or as a secondary application to sheath a hull or replace water-degraded polyester resins and gel coats.

The term 'epoxy' refers to a chemical group consisting of an oxygen atom bonded to two carbon atoms that are already bonded in some way. The simplest epoxy is a three-member ring structure known by the term 'alpha-epoxy' or '1,2-epoxy'. The idealised chemical structure is shown in the figure below and is the most easily identified characteristic of any more complex epoxy molecule.

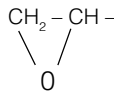

Idealised Chemical Structure of a Simple Epoxy (Ethylene Oxide)

Fig. 19

Usually identifiable by their characteristic amber or brown colouring, epoxy resins have a number of useful properties. Both the liquid resin and the curing agents form low viscosity easily processed systems. Epoxy resins are easily and quickly cured at any temperature from 5°C to 150°C, depending on the choice of curing agent. One of the most advantageous properties of epoxies is their low shrinkage during cure which minimises fabric 'print-through' and internal stresses. High adhesive strength and high mechanical properties are also enhanced by high electrical insulation and good chemical resistance. Epoxies find uses as adhesives, caulking compounds, casting com-

pounds, sealants, varnishes and paints, as well as laminating resins for a variety of industrial applications.

Epoxy resins are formed from a long chain molecular structure similar to vinyl ester with reactive sites at either end. In the epoxy resin, however, these reactive sites are formed by epoxy groups instead of ester groups. The absence of ester groups means that the epoxy resin has particularly good water resistance. The epoxy molecule also contains two ring groups at its centre which are able to absorb both mechanical and thermal stresses better than linear groups and therefore give the epoxy resin very good stiffness, toughness and heat resistant properties.

The figure below shows the idealised chemical structure of a typical epoxy. Note the absence of the ester groups within the molecular chain.

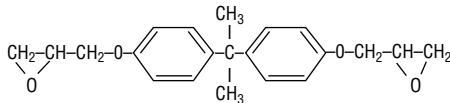

Idealised Chemical Structure of a Typical Epoxy (Diglycidyl Ether of Bisphenol-A)

Fig. 20

Epoxyes differ from polyester resins in that they are cured by a 'hardener' rather than a catalyst. The hardener, often an amine, is used to cure the epoxy by an 'addition reaction' where both materials take place in the chemical reaction. The chemistry of this reaction means that there are usually two epoxy sites binding to each amine site. This forms a complex three-dimensional molecular structure which is illustrated in Fig. 21.

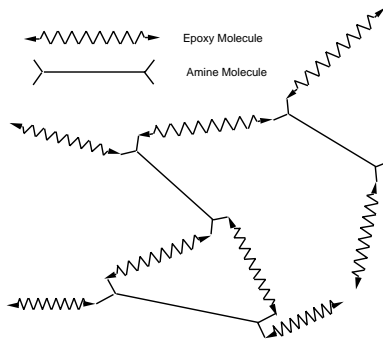

Schematic Representation of Epoxy Resin (Cured 3-D Structure)

Fig. 21

Since the amine molecules 'co-react' with the epoxy molecules in a fixed ratio, it is essential that the correct mix ratio is obtained between resin and hardener to ensure that a complete reaction takes place. If amine and epoxy are not mixed in the correct ratios, unreacted resin or hardener will remain within the matrix which will affect the final properties after cure. To assist with the accurate mixing of the resin and hardener, manufacturers usually formulate the components to give a simple mix ratio which is easily achieved by measuring out by weight or volume.

Gelation, Curing and Post-Curing

On addition of the catalyst or hardener a resin will begin to become more viscous until it reaches a state when it is no longer a liquid and has lost its ability to flow. This is the 'gel point'. The resin will continue to harden after it has gelled, until, at some time later, it has obtained its full hardness and properties. This reaction itself is accompanied by the generation of exothermic heat, which, in turn, speeds the reaction. The whole process is known as the 'curing' of the resin. The speed of cure is controlled by the amount of accelerator in a polyester or vinylester resin and by varying the type, not the quantity, of hardener in an epoxy resin. Generally polyester resins produce a more severe exotherm and a faster development of initial mechanical properties than epoxies of a similar working time.

With both resin types, however, it is possible to accelerate the cure by the application of heat, so that the higher the temperature the faster the final hardening will occur. This can be most useful when the cure would otherwise take several hours or even days at room temperature. A quick rule of thumb for the accelerating effect of heat on a resin is that a 10°C increase in temperature will roughly double the reaction rate. Therefore if a resin gels in a laminate in 25 minutes at 20°C it will gel in about 12 minutes at 30°C, providing no extra exotherm occurs. Curing at elevated temperatures has the added advantage that it actually increases the end mechanical properties of the material, and many resin systems will not reach their ultimate mechanical properties unless the resin is given this 'postcure'. The postcure involves increasing the laminate temperature after the initial room temperature cure, which increases the amount of cross-linking of the molecules that can take place. To some degree this postcure will occur naturally at warm room temperatures, but higher properties and shorter postcure times will be obtained if elevated temperatures are used. This is particularly true of the material's softening point or Glass Transition Temperature (T_g), which, up to a point, increases with increasing postcure temperature.

Comparison of Resin Properties

The choice of a resin system for use in any component depends on a number of its characteristics, with the following probably being the most important for most composite structures:

- 1 Adhesive Properties
- 2 Mechanical Properties
- 3 Micro-Cracking resistance
- 4 Fatigue Resistance
- 5 Degradation From Water Ingress

Adhesive Properties

It has already been discussed how the adhesive properties of the resin system are important in realising the full mechanical properties of a composite. The adhesion of the resin matrix to the fibre reinforcement or to a core material in a sandwich construc-

tion are important. Polyester resins generally have the lowest adhesive properties of the three systems described here. Vinylester resin shows improved adhesive properties over polyester but epoxy systems offer the best performance of all, and are therefore frequently found in many high-strength adhesives. This is due to their chemical composition and the presence of polar hydroxyl and ether groups. As epoxies cure with low shrinkage the various surface contacts set up between the liquid resin and the adherends are not disturbed during the cure. The adhesive properties of epoxy are especially useful in the construction of honeycomb-cored laminates where the small bonding surface area means that maximum adhesion is required.

The strength of the bond between resin and fibre is not solely dependent on the adhesive properties of the resin system but is also affected by the surface coating on the reinforcement fibres. This 'sizing' is discussed later under 'Reinforcements'.

Mechanical Properties

Two important mechanical properties of any resin system are its tensile strength and stiffness. Figs. 22 and 23 show results for tests carried out on commercially available polyester, vinylester and epoxy resin systems cured at 20°C and 80°C.

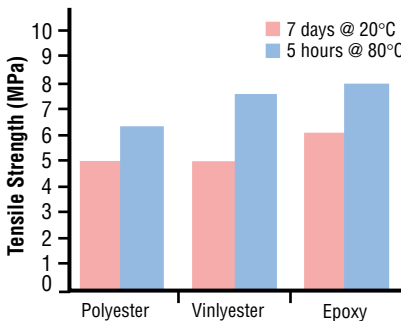

Comparative Tensile Strength of Resins

Fig. 22

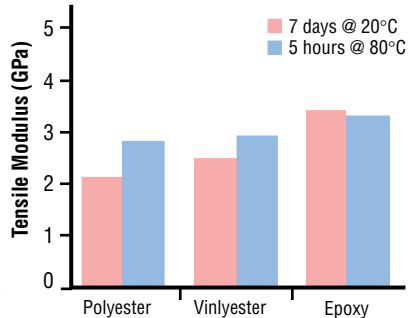

Comparative Stiffness of Resins

Fig. 23

After a cure period of seven days at room temperature it can be seen that a typical epoxy will have higher properties than a typical polyester and vinylester for both strength and stiffness. The beneficial effect of a post cure at 80°C for five hours can also be seen.

Also of importance to the composite designer and builder is the amount of shrinkage that occurs in a resin during and following its cure period. Shrinkage is due to the resin molecules rearranging and re-orientating themselves in the liquid and semi-gelled phase. Polyester and vinylesters require considerable molecular rearrangement to reach their cured state and can show shrinkage of up to 8%. The different nature of the epoxy reaction, however, leads to very little rearrangement and with no volatile bi-products being evolved, typical shrinkage of an epoxy is reduced to around 2%. The absence of shrinkage is, in part, responsible for the improved mechanical properties of epoxies over polyester, as shrinkage is associated with built-in stresses that can weaken the material. Furthermore, shrinkage through the thickness of a laminate

leads to 'print-through' of the pattern of the reinforcing fibres, a cosmetic defect that is difficult and expensive to eliminate.

Micro-Cracking

The strength of a laminate is usually thought of in terms of how much load it can withstand before it suffers complete failure. This ultimate or breaking strength is the point at which the resin exhibits catastrophic breakdown and the fibre reinforcements break.

However, before this ultimate strength is achieved, the laminate will reach a stress level where the resin will begin to crack away from those fibre reinforcements not aligned with the applied load, and these cracks will spread through the resin matrix. This is known as 'transverse micro-cracking' and, although the laminate has not completely failed at this point, the breakdown process has commenced. Consequently, engineers who want a long-lasting structure must ensure that their laminates do not exceed this point under regular service loads.

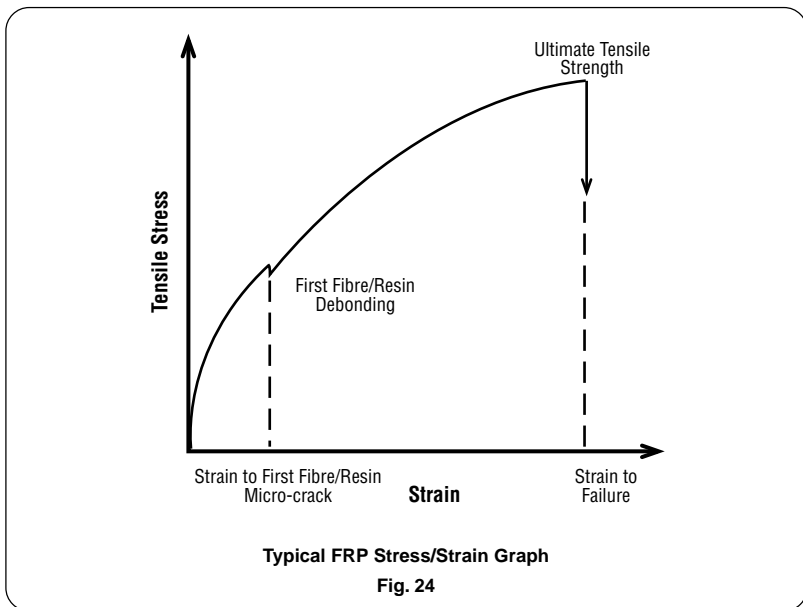

The strain that a laminate can reach before microcracking depends strongly on the toughness and adhesive properties of the resin system. For brittle resin systems, such as most polyesters, this point occurs a long way before laminate failure, and so severely limits the strains to which such laminates can be subjected. As an example, recent tests have shown that for a polyester/glass woven roving laminate, micro-cracking typically occurs at about 0.2% strain with ultimate failure not occurring until 2.0% strain. This equates to a usable strength of only 10% of the ultimate strength.

As the ultimate strength of a laminate in tension is governed by the strength of the fibres, these resin micro-cracks do not immediately reduce the ultimate properties of

the laminate. However, in an environment such as water or moist air, the micro-cracked laminate will absorb considerably more water than an uncracked laminate. This will then lead to an increase in weight, moisture attack on the resin and fibre sizing agents, loss of stiffness and, with time, an eventual drop in ultimate properties.

Increased resin/fibre adhesion is generally derived from both the resin's chemistry and its compatibility with the chemical surface treatments applied to fibres. Here the well-known adhesive properties of epoxy help laminates achieve higher microcracking strains. As has been mentioned previously, resin toughness can be hard to measure, but is broadly indicated by its ultimate strain to failure. A comparison between various resin systems is shown in Fig. 25.

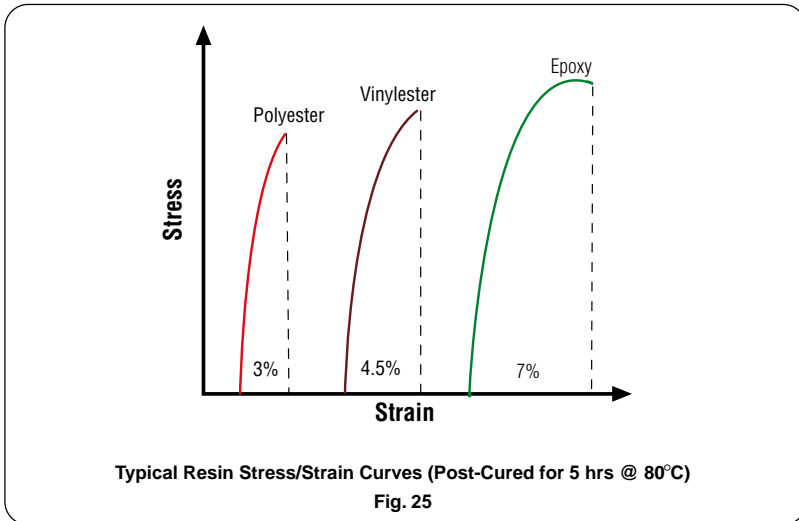

Fatigue Resistance

Generally composites show excellent fatigue resistance when compared with most metals. However, since fatigue failure tends to result from the gradual accumulation of small amounts of damage, the fatigue behaviour of any composite will be influenced by the toughness of the resin, its resistance to microcracking, and the quantity of voids and other defects which occur during manufacture. As a result, epoxy-based laminates tend to show very good fatigue resistance when compared with both polyester and vinylester, this being one of the main reasons for their use in aircraft structures.

Degradation from Water Ingress

An important property of any resin, particularly in a marine environment, is its ability to withstand degradation from water ingress. All resins will absorb some moisture, adding to a laminate's weight, but what is more significant is how the absorbed water affects the resin and resin/fibre bond in a laminate, leading to a gradual and long-term loss in mechanical properties. Both polyester and vinylester resins are prone to water degradation due to the presence of hydrolysable ester groups in their molecular structures. As a result, a thin polyester laminate can be expected to retain only

65% of its inter-laminar shear strength after immersion in water for a period of one year, whereas an epoxy laminate immersed for the same period will retain around 90%.

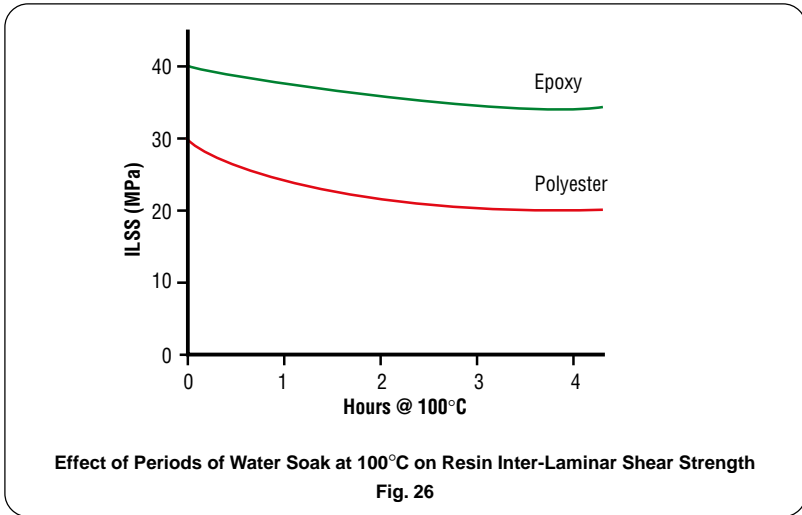

Fig. 26 demonstrates the effects of water on an epoxy and polyester woven glass laminate, which have been subjected to a water soak at 100°C. This elevated temperature soaking gives accelerated degradation properties for the immersed laminate.

Osmosis

All laminates in a marine environment will permit very low quantities of water to pass through them in vapour form. As this water passes through, it reacts with any hydrolysable components inside the laminate to form tiny cells of concentrated solution. Under the osmotic cycle, more water is then drawn through the semi-permeable membrane of the laminate to attempt to dilute this solution. This water increases the fluid pressure in the cell to as much as 700 psi. Eventually the pressure distorts or bursts the laminate or gelcoat, and can lead to a characteristic 'chicken-pox' surface. Hydrolysable components in a laminate can include dirt and debris that have become trapped during fabrication, but can also include the ester linkages in a cured polyester, and to a lesser extent, vinylester.

Use of resin rich layers next to the gel coat are essential with polyester resins to minimise this type of degradation, but often the only cure once the process has started is the replacement of the affected material. To prevent the onset of osmosis from the start, it is necessary to use a resin which has both a low water transmission rate and a high resistance to attack by water. When used with reinforcements with similarly resistant surface treatment and laminated to a very high standard, blistering can then be virtually eliminated. A polymer chain having an epoxy backbone is substantially better than many other resin systems at resisting the effects of water. Such systems have been shown to confer excellent chemical and water resistance, low water transmission rate and very good mechanical properties to the polymer.

Resin Comparison Summary

The polyesters, vinylesters and epoxies discussed here probably account for some 90% of all thermosetting resin systems used in structural composites. In summary the main advantages and disadvantages of each of these types are:

<p>Polyesters Advantages</p> <ul style="list-style-type: none"> Easy to use Lowest cost of resins available (£1-2/kg) 	<p>Disadvantages</p> <ul style="list-style-type: none"> Only moderate mechanical properties High styrene emissions in open moulds High cure shrinkage Limited range of working times
<p>Vinylesters Advantages</p> <ul style="list-style-type: none"> Very high chemical/environmental resistance Higher mechanical properties than polyesters 	<p>Disadvantages</p> <ul style="list-style-type: none"> Postcure generally required for high properties High styrene content Higher cost than polyesters (£2-4/kg) High cure shrinkage
<p>Epoxies Advantages</p> <ul style="list-style-type: none"> High mechanical and thermal properties High water resistance Long working times available Temperature resistance can be up to 140°C wet / 220°C dry Low cure shrinkage 	<p>Disadvantages</p> <ul style="list-style-type: none"> More expensive than vinylesters (£3-15/kg) Critical mixing Corrosive handling

Other Resin Systems used in Composites

Besides polyesters, vinylesters and epoxies there are a number of other specialised resin systems that are used where their unique properties are required:

Phenolics

Primarily used where high fire-resistance is required, phenolics also retain their properties well at elevated temperatures. For room-temperature curing materials, corrosive acids are used which leads to unpleasant handling. The condensation nature of their curing process tends to lead to the inclusion of many voids and surface defects, and the resins tend to be brittle and do not have high mechanical properties. Typical costs: £2-4/kg.

Cyanate Esters

Primarily used in the aerospace industry. The material's excellent dielectric properties make it very suitable for use with low dielectric fibres such as quartz for the manufacture of radomes. The material also has temperature stability up to around 200°C wet. Typical costs: £40/kg.

Silicones

Synthetic resin using silicon as the backbone rather than the carbon of organic polymers. Good fire-resistant properties, and able to withstand elevated temperatures. High temperature cures needed. Used in missile applications. Typical costs: >£15/kg.

Polyurethanes

High toughness materials, sometimes hybridised with other resins, due to relatively low laminate mechanical properties in compression. Uses harmful isocyanates as curing agent. Typical costs: £2-8/kg

Bismaleimides (BMI)

Primarily used in aircraft composites where operation at higher temperatures (230°C wet/250°C dry) is required. e.g. engine inlets, high speed aircraft flight surfaces. Typical costs: >£50/kg.

Polyimides

Used where operation at higher temperatures than bismaleimides can stand is required (use up to 250°C wet/300°C dry). Typical applications include missile and aero-engine components. Extremely expensive resin (>£80/kg), which uses toxic raw materials in its manufacture. Polyimides also tend to be hard to process due to their condensation reaction emitting water during cure, and are relatively brittle when cured. PMR15 and LaRC160 are two of the most commonly used polyimides for composites.



Resin Systems Such as Silicones, BMI's and Polyimides are Frequently Used for High Temperature Aircraft Parts.

Reinforcements

The role of the reinforcement in a composite material is fundamentally one of increasing the mechanical properties of the neat resin system. All of the different fibres used in composites have different properties and so affect the properties of the composite in different ways. The properties and characteristics of common fibres are explained below.

However, individual fibres or fibre bundles can only be used on their own in a few processes such as filament winding (described later). For most other applications, the fibres need to be arranged into some form of sheet, known as a fabric, to make handling possible. Different ways for assembling fibres into sheets and the variety of fibre orientations possible lead to there being many different types of fabrics, each of which has its own characteristics. These different fabric types and constructions are explained later.

Properties of Reinforcing Fibres & Finishes



The mechanical properties of most reinforcing fibres are considerably higher than those of un-reinforced resin systems. The mechanical properties of the fibre/resin composite are therefore dominated by the contribution of the fibre to the composite.

The four main factors that govern the fibre's contribution are:

1. The basic mechanical properties of the fibre itself.
2. The surface interaction of fibre and resin (the 'interface').
3. The amount of fibre in the composite ('Fibre Volume Fraction').
4. The orientation of the fibres in the composite.

The basic mechanical properties of the most commonly used fibres are given in the following table. The surface interaction of fibre and resin is controlled by the degree of bonding that exists between the two. This is heavily influenced by the treatment given to the fibre surface, and a description of the different surface treatments and 'finishes' is also given here.

The amount of fibre in the composite is largely governed by the manufacturing process used. However, reinforcing fabrics with closely packed fibres will give higher Fibre Volume Fractions (FVF) in a laminate than will those fabrics which are made with coarser fibres, or which have large gaps between the fibre bundles. Fibre diameter is an important factor here with the more expensive smaller diameter fibres providing higher fibre surface areas, spreading the fibre/matrix interfacial loads. As a general rule, the stiffness and strength of a laminate will increase in proportion to the amount of fibre present. However, above about 60-70% FVF (depending on the way in which the fibres pack together) although tensile stiffness may continue to increase, the laminate's strength will reach a peak and then begin to decrease due to the lack of sufficient resin to hold the fibres together properly.

Finally, since reinforcing fibres are designed to be loaded along their length, and not across their width, the orientation of the fibres creates highly 'direction-specific' properties in the composite. This 'anisotropic' feature of composites can be used to good advantage in designs, with the majority of fibres being placed along the orientation of the main load paths. This minimises the amount of parasitic material that is put in orientations where there is little or no load.

Basic Properties of Fibres and Other Engineering Materials

Material Type	Tensile Str. (MPa)	Tensile Modulus (GPa)	Typical Density (g/cc)	Specific Modulus
Carbon HS	3500	160 - 270	1.8	90 - 150
Carbon IM	5300	270 - 325	1.8	150 - 180
Carbon HM	3500	325 - 440	1.8	180 - 240
Carbon UHM	2000	440+	2.0	200+
Aramid LM	3600	60	1.45	40
Aramid HM	3100	120	1.45	80
Aramid UHM	3400	180	1.47	120
Glass - E glass	2400	69	2.5	27
Glass - S2 glass	3450	86	2.5	34
Glass - quartz	3700	69	2.2	31
Aluminium Alloy (7020)	400	1069	2.7	26
Titanium	950	110	4.5	24
Mild Steel (55 Grade)	450	205	7.8	26
Stainless Steel (A5-80)	800	196	7.8	25
HS Steel (17/4 H900)	1241	197	7.8	25

Laminate Mechanical Properties

The properties of the fibres given above only shows part of the picture. The properties of the composite will derive from those of the fibre, but also the way it interacts with the resin system used, the resin properties itself, the volume of fibre in the composite and its orientation. The following diagrams show a basic comparison of the main fibre types when used in a typical high-performance unidirectional epoxy prepreg, at the fibre volume fractions that are commonly achieved in aerospace components.

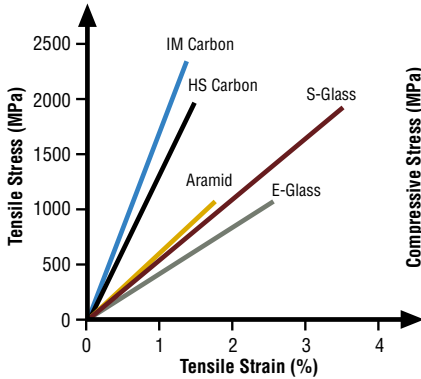

Tensile Properties of U/D Prepreg Laminate
Fig. 27

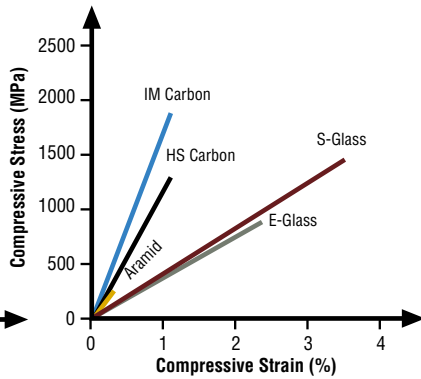

Compressive Properties of U/D Prepreg Laminates
Fig. 28

These graphs show the strengths and maximum strains of the different composites at failure. The gradient of each graph also indicates the stiffness (modulus) of the composite; the steeper the gradient, the higher its stiffness. The graphs also show how some fibres, such as aramid, display very different properties when loaded in compression, compared with loading in tension.

Laminate Impact Strength

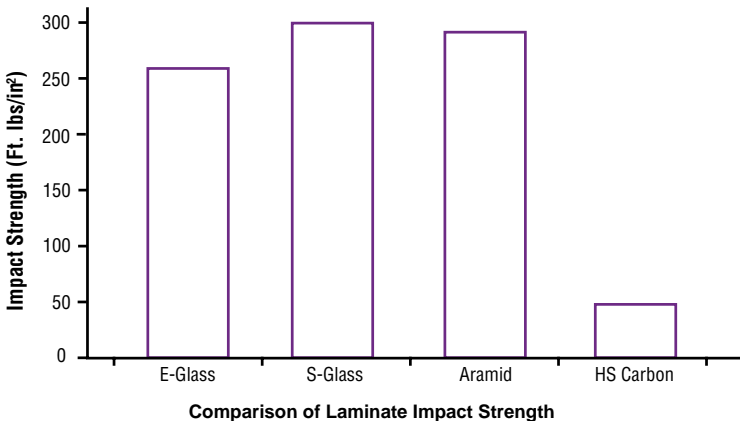

Fig. 29

Impact damage can pose particular problems when using high stiffness fibres in very thin laminates. In some structures, where cores are used, laminate skins can be less than 0.3mm thick. Although other factors such as weave style and fibre orientation can significantly affect impact resistance, in impact-critical applications, carbon is often found in combination with one of the other fibres. This can be in the form of a hybrid fabric where more than one fibre type is used in the fabric construction. These are described in more detail later.

Comparative Fibre Cost

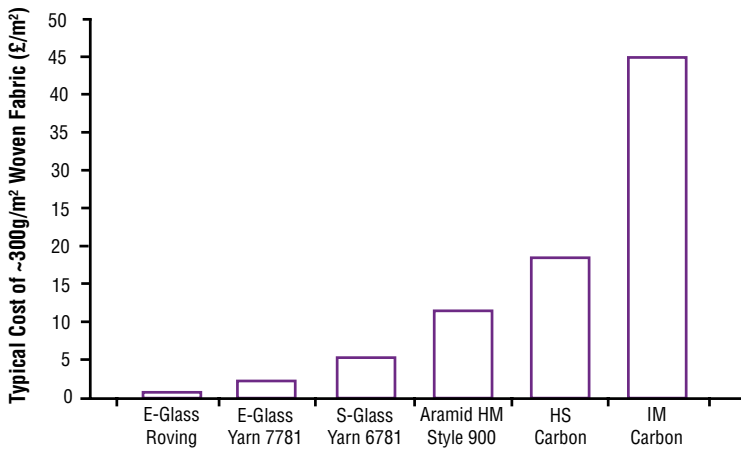

Fig. 30

The figures above are calculated on a typical price of a 300g woven fabric. Most fibre prices are considerably higher for the small bundle size (tex) used in such lightweight fabrics. Where heavier bundles of fibre can be used, such as in unidirectional fabrics, the cost comparison is slightly different.

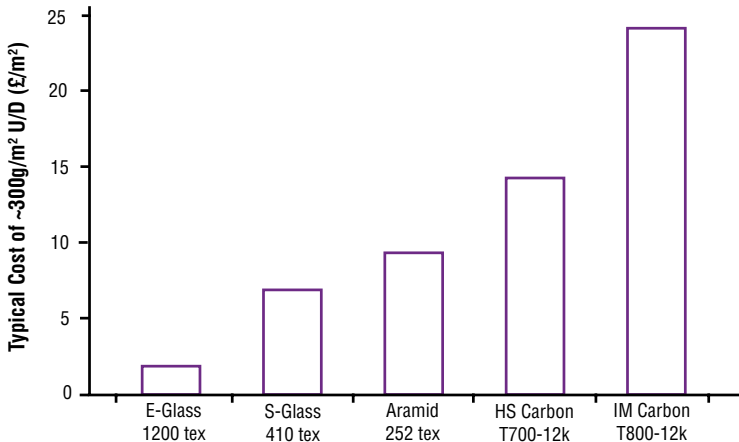

Fig. 31

Fibre Types

Glass

By blending quarry products (sand, kaolin, limestone, colemanite) at 1,600°C, liquid glass is formed. The liquid is passed through micro-fine bushings and simultaneously cooled to produce glass fibre filaments from 5-24µm in diameter. The filaments are drawn together into a strand (closely associated) or roving (loosely associated), and coated with a "size" to provide filament cohesion and protect the glass from abrasion.

By variation of the "recipe", different types of glass can be produced. The types used for structural reinforcements are as follows:

- a. E-glass (electrical) - lower alkali content and stronger than A glass (alkali). Good tensile and compressive strength and stiffness, good electrical properties and relatively low cost, but impact resistance relatively poor. Depending on the type of E glass the price ranges from about £1-2/kg. E-glass is the most common form of reinforcing fibre used in polymer matrix composites.
- b. C-glass (chemical) - best resistance to chemical attack. Mainly used in the form of surface tissue in the outer layer of laminates used in chemical and water pipes and tanks.
- c. R, S or T-glass – manufacturers trade names for equivalent fibres having higher tensile strength and modulus than E glass, with better wet strength retention. Higher ILSS and wet out properties are achieved through smaller filament diameter. S-glass is produced in the USA by OCF, R-glass in Europe by Vetrotex and T-glass by Nittobo in Japan. Developed for aerospace and defence industries, and used in some hard ballistic armour applications. This factor, and low production volumes mean relatively high price. Depending on the type of R or S glass the price ranges from about £12-20/kg.

E Glass Fibre Types

E Glass fibre is available in the following forms:

- a. strand - a compactly associated bundle of filaments. Strands are rarely seen commercially and are usually twisted together to give yarns.
- b. yarns - a closely associated bundle of twisted filaments or strands. Each filament diameter in a yarn is the same, and is usually between 4-13µm. Yarns have varying weights described by their 'tex' (the weight in grammes of 1000 linear metres) or denier (the weight in lbs of 10,000 yards), with the typical tex range usually being between 5 and 400.
- c. rovings - a loosely associated bundle of untwisted filaments or strands. Each filament diameter in a roving is the same, and is usually between 13-24µm. Rovings also have varying weights and the tex range is usually between 300 and 4800. Where filaments are gathered together directly after the melting process, the resultant fibre bundle is known as a direct roving. Several strands can also be brought together separately after manufacture of the glass, to give what is known as an assembled roving. Assembled rovings usually have smaller filament diam-



eters than direct rovings, giving better wet-out and mechanical properties, but they can suffer from catenary problems (unequal strand tension), and are usually higher in cost because of the more involved manufacturing processes.

It is also possible to obtain long fibres of glass from short fibres by spinning them. These spun yarn fibres have higher surface areas and are more able to absorb resin, but they have lower structural properties than the equivalent continuously drawn fibres.

Glass Fibre Designation

Glass fibres are designated by the following internationally recognised terminology:

glass type	yarn type	filament diameter (μ)	strand weight (tex)	single strand twist	no. of multi strand strands	multi strand twist	no. turns per metre
E	C	9	34	Z	X2	S	150

E = Electrical C = Continuous
S = High Strength

Z = Clockwise
S = Anti-clockwise

Aramid

Aramid fibre is a man-made organic polymer (an aromatic polyamide) produced by spinning a solid fibre from a liquid chemical blend. The bright golden yellow filaments produced can have a range of properties, but all have high strength and low density giving very high specific strength. All grades have good resistance to impact, and lower modulus grades are used extensively in ballistic applications. Compressive strength, however, is only similar to that of E glass.



Although most commonly known under its Dupont trade name 'Kevlar', there are now a number of suppliers of the fibre, most notably Akzo Nobel with 'Twaron'. Each supplier offers several grades of aramid with various combinations of modulus and surface finish to suit various applications. As well as the high strength properties, the fibres also offer good resistance to abrasion, and chemical and thermal degradation. However, the fibre can degrade slowly when exposed to ultraviolet light.

Aramid fibres are usually available in the form of rovings, with texes ranging from about 20 to 800. Typically the price of the high modulus type ranges from £15-to £25 per kg.

Carbon

Carbon fibre is produced by the controlled oxidation, carbonisation and graphitisation of carbon-rich organic precursors which are already in fibre form. The most common precursor is polyacrylonitrile (PAN), because it gives the best carbon fibre properties, but fibres can also be made from pitch or cellulose. Variation of the graphitisation process produces either high strength fibres (@ ~2,600°C) or high modulus fibres (@ ~3,000°C) with other types in

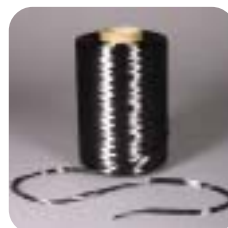

between. Once formed, the carbon fibre has a surface treatment applied to improve matrix bonding and chemical sizing which serves to protect it during handling.

When carbon fibre was first produced in the late sixties the price for the basic high strength grade was about £200/kg. By 1996 the annual worldwide capacity had increased to about 7,000 tonnes and the price for the equivalent (high strength) grade was £15-40/kg. Carbon fibres are usually grouped according to the modulus band in which their properties fall. These bands are commonly referred to as: high strength (HS), intermediate modulus (IM), high modulus (HM) and ultra high modulus (UHM). The filament diameter of most types is about 5-7µm. Carbon fibre has the highest specific stiffness of any commercially available fibre, very high strength in both tension and compression and a high resistance to corrosion, creep and fatigue. Their impact strength, however, is lower than either glass or aramid, with particularly brittle characteristics being exhibited by HM and UHM fibres.

Strength and Modulus Figures for Commercial PAN-based Carbon Fibres

Grade	Tensile Modulus (GPa)	Tensile Strength (GPa)	Country of Manufacture
Standard Modulus (<265GPa) (also known as 'High Strength')			
T300	230	3.53	France/Japan
T700	235	5.3	Japan
HTA	238	3.95	Germany
UTS	240	4.8	Japan
34-700	234	4.5	Japan/USA
AS4	241	4.0	USA
T650-35	241	4.55	USA
Panex 33	228	3.6	USA/Hungary
F3C	228	3.8	USA
TR50S	235	4.83	Japan
TR30S	234	4.41	Japan
Intermediate Modulus (265-320GPa)			
T800	294	5.94	France/Japan
M30S	294	5.49	France
IMS	295	4.12/5.5	Japan
MR40/MR50	289	4.4/5.1	Japan
IM6/IM7	303	5.1/5.3	USA
IM9	310	5.3	USA
T650-42	290	4.82	USA
T40	290	5.65	USA
High Modulus (320-440GPa)			
M40	392	2.74	Japan
M40J	377	4.41	France/Japan
HMA	358	3.0	Japan
UMS2526	395	4.56	Japan
MS40	340	4.8	Japan
HR40	381	4.8	Japan
Ultra High Modulus (~440GPa)			
M46J	436	4.21	Japan
UMS3536	435	4.5	Japan
HS40	441	4.4	Japan
UHMS	441	3.45	USA

Information from manufacturer's datasheets

Fibre Type Comparisons

Comparing the properties of all of the fibre types with each other, shows that they all have distinct advantages and disadvantages. This makes different fibre types more suitable for some applications than others. The following table provides a basic comparison between the main desirable features of generic fibre types. 'A' indicates a feature where the fibre scores well, and 'C' indicates a feature where the fibre is not so good.

Property	Aramid	Carbon	Glass
High Tensile Strength	B	A	B
High Tensile Modulus	B	A	C
High Compressive Strength	C	A	B
High Compressive Modulus	B	A	C
High Flexural Strength	C	A	B
High Flexural Modulus	B	A	C
High Impact Strength	A	C	B
High Interlaminar Shear Strength	B	A	A
High In-plane Shear Strength	B	A	A
Low Density	A	B	C
High Fatigue Resistance	B	A	C
High Fire Resistance	A	C	A
High Thermal Insulation	A	C	B
High Electrical Insulation	B	C	A
Low Thermal Expansion	A	A	A
Low Cost	C	C	A

Other Fibres

There are a variety of other fibres which can be used in advanced composite structures but their use is not widespread. These include:

Polyester

A low density, high tenacity fibre with good impact resistance but low modulus. Its lack of stiffness usually precludes it from inclusion in a composite component, but it is useful where low weight, high impact or abrasion resistance, and low cost are required. It is mainly used as a surfacing material, as it can be very smooth, keeps weight down and works well with most resin types.

Polyethylene

In random orientation, ultra-high molecular weight polyethylene molecules give very low mechanical properties. However, if dissolved and drawn from solution into a filament by a process called gel-spinning, the molecules become disentangled and aligned in the direction of the filament. The molecular alignment promotes very high tensile strength to the filament and the resulting fibre. Coupled with their low S.G. (<1.0), these fibres have the highest specific strength of the fibres described here. However, the fibre's tensile modulus and ultimate strength are only slightly better than E-glass and less than that of aramid or carbon. The fibre also demonstrates very low compressive strength in laminate form. These factors, coupled with high price, and more importantly, the difficulty in creating a good fibre/matrix bond means that polyethylene fibres are not often used in isolation for composite components.

Quartz

A very high silica version of glass with much higher mechanical properties and excellent resistance to high temperatures (1,000°C+). However, the manufacturing process and low volume production lead to a very high price (14µm - £74/kg, 9µm - £120/kg).

Boron

Carbon or metal fibres are coated with a layer of boron to improve the overall fibre properties. The extremely high cost of this fibre restricts its use to high temperature aerospace applications and in specialised sporting equipment. A boron/carbon hybrid, composed of carbon fibres interspersed among 80-100µm boron fibres, in an epoxy matrix, can achieve properties greater than either fibre alone, with flexural strength and stiffness twice that of HS carbon and 1.4 times that of boron, and shear strength exceeding that of either fibre.

Ceramics

Ceramic fibres, usually in the form of very short 'whiskers' are mainly used in areas requiring high temperature resistance. They are more frequently associated with non-polymer matrices such as metal alloys.

Natural

At the other end of the scale it is possible to use fibrous plant materials such as jute and sisal as reinforcements in 'low-tech' applications. In these applications, the fibres' low S.G. (typically 0.5-0.6) mean that fairly high specific strengths can be achieved.

Fibre Finishes

Surface finishes are nearly always applied to fibres both to allow handling with minimum damage and to promote fibre/matrix interfacial bond strength. With carbon and aramid fibres for use in composite applications, the surface finish or size applied usually performs both functions. The finish is applied to the fibre at the point of fibre manufacture and this finish remains on the fibre throughout the conversion process into fabric. With glass fibre there is a choice of approach in the surface finish that can be applied.

Glass Fibre Finishes

Glass fibre rovings that are to be used in direct fibre processes such as prepregging, pultrusion and filament winding, are treated with a 'dual-function' finish at the point of fibre manufacture.



Glass fibre yarns, however, when used for weaving are treated in two stages. The first finish is applied at the point of fibre manufacture at quite a high level and is purely for protection of the fibre against damage during handling and the weaving process itself. This protective finish, which is often starch based, is cleaned off or 'scoured' after the weaving process either by heat or with chemicals. The scoured woven fabric is then separately treated with a different matrix-compatible finish specifically designed to optimise fibre to resin interfacial characteristics such as bond strength, water resistance and optical clarity.

Carbon Fibre Finishes

Finishes, or sizes, for carbon fibres used in structural composites are generally epoxy based, with varying levels being used depending on the end use of the fibre. For weaving the size level is about 1-2% by weight whereas for tape prepregging or filament winding (or similar single-fibre processes), the size level is about 0.5-1%. The chemistry and level of the size are important not only for protection and matrix compatibility but also because they effect the degree of spread of the fibre. Fibres can also be supplied unsized but these will be prone to broken filaments caused by general handling. Most carbon fibre suppliers offer 3-4 levels of size for each grade of fibre.

Aramid Fibre Finishes

Aramid fibres are treated with a finish at the point of manufacture primarily for matrix compatibility. This is because aramid fibres require far less protection from damage caused by fibre handling. The main types of fibre treatment are composite finish, rubber compatible finish (belts and tyres) and waterproof finish (ballistic soft armour). Like the carbon fibre finishes, there are differing levels of composite application finish depending on the type of process in which the fibre will be used.

Fabric Types and Constructions

In polymeric composite terms, a fabric is defined as a manufactured assembly of long fibres of carbon, aramid or glass, or a combination of these, to produce a flat sheet of one or more layers of fibres. These layers are held together either by mechanical interlocking of the fibres themselves or with a secondary material to bind these fibres together and hold them in place, giving the assembly sufficient integrity to be handled.

Fabric types are categorised by the orientation of the fibres used, and by the various construction methods used to hold the fibres together.

The four main fibre orientation categories are: Unidirectional, 0/90°, Multiaxial, and Other/random. These are described below.

Unidirectional Fabrics

A unidirectional (UD) fabric is one in which the majority of fibres run in one direction only. A small amount of fibre or other material may run in other directions with the main intention being to hold the primary fibres in position, although the other fibres may also offer some structural properties. While some weavers of 0/90° fabrics term a fabric with only 75% of its weight in one direction as a unidirectional, at SP the unidirectional designation only applies to those fabrics with more than 90% of the fibre weight in one direction. Unidirectionals usually have their primary fibres in the 0° direction (along the roll – a warp UD) but can also have them at 90° to the roll length (a weft UD).



True unidirectional fabrics offer the ability to place fibre in the component exactly where it is required, and in the optimum quantity (no more or less than required). As well as this, UD fibres are straight and uncrimped. This results in the highest possible fibre properties from a fabric in composite component construction. For mechanical properties, unidirectional fabrics can only be improved on by prepreg unidirectional tape, where there is no secondary material at all holding the unidirectional fibres in place. In these prepreg products only the resin system holds the fibres in place.

Unidirectional Construction

There are various methods of maintaining the primary fibres in position in a unidirectional including weaving, stitching, and bonding. As with other fabrics, the surface quality of a unidirectional fabric is determined by two main factors: the combination of tex and thread count of the primary fibre and the amount and type of the secondary fibre. The drape, surface smoothness and stability of a fabric are controlled primarily by the construction style, while the area weight, porosity and (to a lesser degree) wet out are determined by selecting the appropriate combination of fibre tex and numbers of fibres per cm.

Warp or weft unidirectionals can be made by the stitching process (see information in the 'Multiaxial' section of this publication). However, in order to gain adequate stability, it is usually necessary to add a mat or tissue to the face of the fabric. Therefore, together with the stitching thread required to assemble the fibres, there is a relatively large amount of secondary, parasitic material in this type of UD fabric, which tends to reduce the laminate properties. Furthermore the high cost of set up of the 0° layer of a stitching line and the relatively slow speed of production means that these fabrics can be relatively expensive.

0/90° Fabrics

For applications where more than one fibre orientation is required, a fabric combining 0° and 90° fibre orientations is useful. The majority of these are woven products. 0/90° fabrics can be produced by stitching rather than a weaving process and a description of this stitching technology is given below under 'Multiaxial Fabrics'.

Woven Fabrics

Woven fabrics are produced by the interlacing of warp (0°) fibres and weft (90°) fibres in a regular pattern or weave style. The fabric's integrity is maintained by the mechanical interlocking of the fibres. Drape (the ability of a fabric to conform to a complex surface), surface smoothness and stability of a fabric are controlled primarily by the weave style. The area weight, porosity and (to a lesser degree) wet out are determined by selecting the correct combination of fibre tex and the number of fibres/cm². The following is a description of some of the more commonly found weave styles:

Plain

Each warp fibre passes alternately under and over each weft fibre. The fabric is symmetrical, with good stability and reasonable porosity. However, it is the most difficult of the weaves to drape, and the high level of fibre crimp imparts relatively low mechanical properties compared with the other weave styles. With large fibres (high tex) this weave style gives excessive crimp and therefore it tends not to be used for very heavy fabrics.

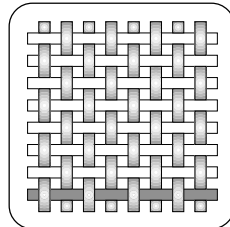

Twill

One or more warp fibres alternately weave over and under two or more weft fibres in a regular repeated manner. This produces the visual effect of a straight or broken diagonal 'rib' to the fabric. Superior wet out and drape is seen in the twill weave over the plain weave with only a small reduction in stability. With reduced crimp, the fabric also has a smoother surface and slightly higher mechanical properties.

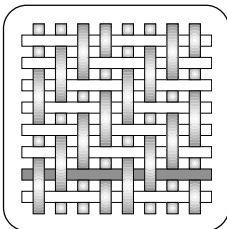

Satin

Satin weaves are fundamentally twill weaves modified to produce fewer intersections of warp and weft. The 'harness' number used in the designation (typically 4, 5 and 8) is the total number of fibres crossed and passed under, before the fibre repeats the pattern. A 'crowsfoot' weave is a form of satin weave with a different stagger in the repeat pattern. Satin weaves are very flat, have good wet out and a high degree of drape. The low crimp gives good mechanical properties. Satin weaves allow fibres to be woven in the closest proximity and can produce fabrics with a close 'tight' weave. However, the style's low stability and asymmetry needs to be considered. The asymmetry causes one face of the fabric to have fibre running predominantly in the warp direction while the other face has fibres running predominantly in the weft direction. Care must be taken in assembling multiple layers of these fabrics to ensure that stresses are not built into the component through this asymmetric effect.

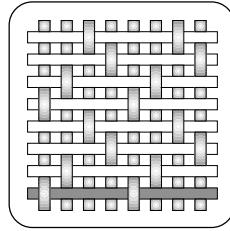

Basket

Basket weave is fundamentally the same as plain weave except that two or more warp fibres alternately interlace with two or more weft fibres. An arrangement of two warps crossing two wefts is designated 2x2 basket, but the arrangement of fibre need not be symmetrical. Therefore it is possible to have 8x2, 5x4, etc. Basket weave is flatter, and, through less crimp, stronger than a plain weave, but less stable. It must be used on heavy weight fabrics made with thick (high tex) fibres to avoid excessive crimping.

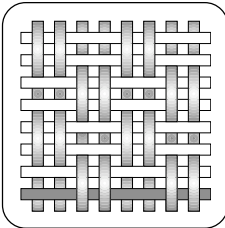

Leno

Leno weave improves the stability in 'open' fabrics which have a low fibre count. A form of plain weave in which adjacent warp fibres are twisted around consecutive weft fibres to form a spiral pair, effectively 'locking' each weft in place. Fabrics in leno weave are normally used in conjunction with other weave styles because if used alone their openness could not produce an effective composite component.

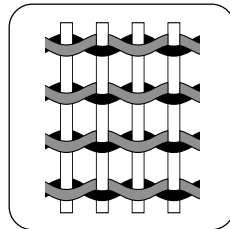

Mock Leno

A version of plain weave in which occasional warp fibres, at regular intervals but usually several fibres apart, deviate from the alternate under-over interlacing and instead interlace every two or more fibres. This happens with similar frequency in the weft direction, and the overall effect is a fabric with increased thickness, rougher surface, and additional porosity.

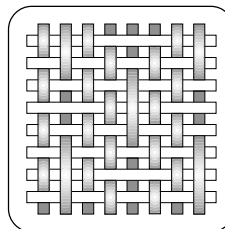

Weave Styles - Comparison of Properties

Property	Plain	Twill	Satin	Basket	Leno	Mock leno
Good stability	****	***	**	**	*****	***
Good drape	**	****	*****	***	*	**
Low porosity	***	****	*****	**	*	***
Smoothness	**	***	*****	**	*	**
Balance	****	****	**	****	**	****
Symmetrical	*****	***	*	***	*	****
Low crimp	**	***	*****	**	**/*	**

***** = excellent, **** = good, *** = acceptable, ** = poor, * = very poor

Quadran Weave Style

Quadran is a special weave style developed by SP to facilitate laminating over large surface areas. The fabric, in any fibre, is woven in 4-Harness satin style, to give a good combination of drape, wet out and air release. Tracers are included in both the warp and weft fibres for alignment of the fabric as it is laid in the mould - blue (polyester) tracers in glass, yellow (aramid) tracers in carbon fabrics. The edges of the fabric are tapered in thickness so that adjacent fabrics can be overlapped with minimum thickness increase. Reducing the tex of the fibres in the warp at the edges, usually 30mm in from the fabric selvedge, creates the tapering effect.

Woven Glass Yarn Fabrics vs Woven Rovings



Yarn-based fabrics generally give higher strengths per unit weight than roving, and being generally finer, produce fabrics at the lighter end of the available weight range. Woven rovings are less expensive to produce and can wet out more effectively. However, since they are available only in heavier texes, they can only produce fabrics at the medium to heavy end of the available weight range, and are thus more suitable for thick, heavier laminates.

The table below covers some of the selection criteria to be applied when considering the use of a Woven Glass Yarn Fibre for a composite component.

Stitched 0/90° Fabrics

0/90° fabrics can also be made by a stitching process, which effectively combines two layers of unidirectional material into one fabric.

Stitched 0/90° fabrics can offer mechanical performance increases of up to 20% in some properties over woven fabrics, due to the following factors:

1. Parallel non-crimp fibres bear the strain immediately upon being loaded.
2. Stress points found at the intersection of warp and weft fibres in woven fabrics are eliminated.
3. A higher density of fibre can be packed into a laminate compared with a woven. In this respect the fabric behaves more like layers of unidirectional.

Other benefits compared with woven fabrics include:

1. Heavy fabrics can be easily produced with more than 1kg/sqm of fibre.
2. Increase packing of the fibre can reduce the quantity of resin required.

Hybrid Fabrics



The term hybrid refers to a fabric that has more than one type of structural fibre in its construction. In a multi-layer laminate if the properties of more than one type of fibre are required, then it would be possible to provide this with two fabrics, each containing the fibre type needed. However, if low weight or extremely thin laminates are required, a hybrid fabric will allow the two fibres to be presented in just one layer of fabric instead of two. It would be possible in a woven hybrid to have one fibre running in the weft direction and the second fibre running in the warp direction, but it is more common to find alternating threads of each fibre in each warp/weft direction. Although hybrids are most commonly found in 0/90° woven fabrics, the principle is also used in 0/90° stitched, unidirectional and multiaxial fabrics. The most usual hybrid combinations are:

Carbon / Aramid

The high impact resistance and tensile strength of the aramid fibre combines with high the compressive and tensile strength of carbon. Both fibres have low density but relatively high cost.

Aramid / Glass

The low density, high impact resistance and tensile strength of aramid fibre combines with the good compressive and tensile strength of glass, coupled with its lower cost.

Carbon / Glass

Carbon fibre contributes high tensile compressive strength and stiffness and reduces the density, while glass reduces the cost.

Multiaxial Fabrics

In recent years multiaxial fabrics have begun to find favour in the construction of composite components. These fabrics consist of one or more layers of long fibres held in place by a secondary non-structural stitching thread. The main fibres can be any of the structural fibres available in any combination. The stitching thread is usually polyester due to its combination of appropriate fibre properties (for binding the fabric together) and cost. The stitching process allows a variety of fibre orientations, beyond the simple 0/90° of woven fabrics, to be combined into one fabric. Multiaxial fabrics have the following main characteristics:

Advantages

The two key improvements with stitched multiaxial fabrics over woven types are:

- (i) **Better mechanical properties**, primarily from the fact that the fibres are always straight and non-crimped, and that more orientations of fibre are available from the increased number of layers of fabric.
- (ii) **Improved component build speed** based on the fact that fabrics can be made thicker and with multiple fibre orientations so that fewer layers need to be included in the laminate sequence.

Disadvantages

Polyester fibre does not bond very well to some resin systems and so the stitching can be a starting point for wicking or other failure initiation. The fabric production process can also be slow and the cost of the machinery high. This, together with the fact that the more expensive, low tex fibres are required to get good surface coverage for the low weight fabrics, means the cost of good quality, stitched fabrics can be relatively high compared to wovens. Extremely heavy weight fabrics, while enabling large quantities of fibre to be incorporated rapidly into the component, can also be difficult to impregnate with resin without some automated process. Finally, the stitching process, unless carefully controlled as in the SP fabric styles, can bunch together the fibres, particularly in the 0° direction, creating resin-rich areas in the laminate.

Fabric Construction

The most common forms of this type of fabric are shown in the following diagrams:

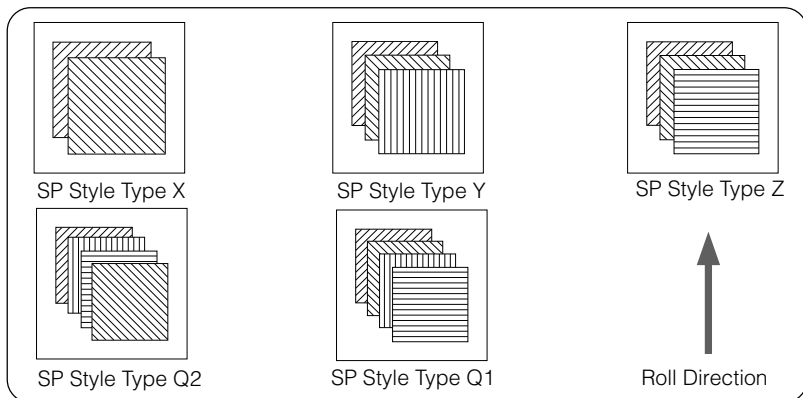

There are two basic ways of manufacturing multiaxial fabrics:

Weave & Stitch

With the 'Weave & Stitch' method the $+45^\circ$ and -45° layers can be made by weaving weft Unidirectionals and then skewing the fabric, on a special machine, to 45° . A warp unidirectional or a weft unidirectional can also be used unskewed to make a 0° and 90° layer. If both 0° and 90° layers are present in a multi-layer stitched fabric then this can be provided by a conventional $0/90^\circ$ woven fabric. Due to the fact that heavy rovings can be used to make each layer the weaving process is relatively fast, as is the subsequent stitching together of the layers via a simple stitching frame.

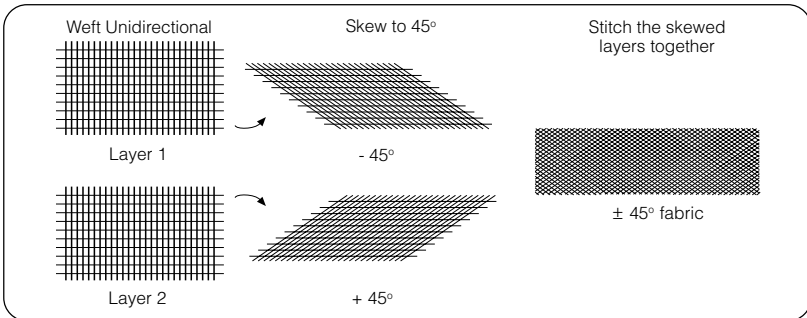

To make a quadraxial (four-layer: $+45^\circ$, 0° , 90° , -45°) fabric by this method, a weft unidirectional would be woven and skewed in one direction to make the $+45^\circ$ layer, and in the other to make the -45° layer. The 0° and 90° layers would appear as a single woven fabric. These three elements would then be stitched together on a stitching frame to produce the final four-axis fabric.

Simultaneous Stitch

Simultaneous stitch manufacture is carried out on special machines based on the knitting process, such as those made by Liba, Malimo, Mayer, etc. Each machine varies in the precision with which the fibres are laid down, particularly with reference to keeping the fibres parallel. These types of machine have a frame which simultaneously draws in fibres for each axis/layer, until the required layers have been assembled, and then stitches them together, as shown in the diagram below.

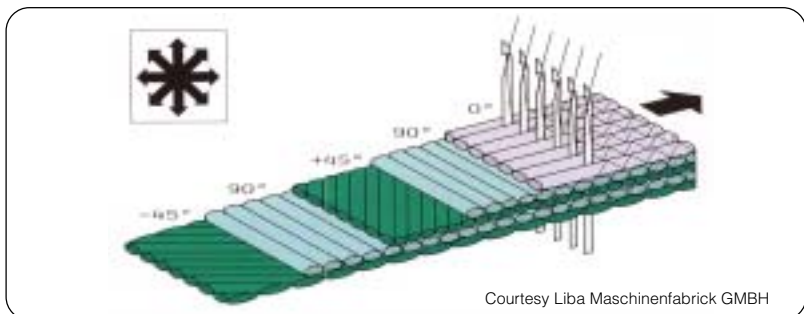

Other Fabrics

Chopped Strand Mat

Chopped strand mat (CSM) is a non-woven material which, as its name implies, consists of randomly orientated chopped strands of glass which are held together - for marine applications - by a PVA emulsion or a powder binder. Despite the fact that PVA imparts superior draping handling and wetting out characteristics users in a marine environment should be wary of its use as it is affected by moisture and can lead to osmosis like blisters.

Today, chopped strand mat is rarely used in high performance composite components as it is impossible to produce a laminate with a high fibre content and, by definition, a high strength-to-weight ratio.

Tissues

Tissues are made with continuous filaments of fibre spread uniformly but randomly over a flat surface. These are then chemically bound together with organic based binding agents such as PVA, polyester, etc. Having relatively low strength they are not primarily used as reinforcements, but as surfacing layers on laminates in order to provide a smooth finish. Tissues are usually manufactured with area weights of between 5 and 50g/sqm. Glass tissues are commonly used to create a corrosion resistant barrier through resin enrichment at the surface. The same enrichment process can also prevent print-through of highly crimped fabrics in gelcoat surfaces.

Braids

Braids are produced by interlacing fibres in a spiral nature to form a tubular fabric. The diameter of the tube is controlled by the number of fibres in the tube's circumference, the angle of the fibres in the spiral, the number of intersections of fibre per unit length of the tube and the size (tex) of the fibres in the assembly. The interlacing can vary in style (plain, twill, etc.) as with 0/90° woven fabrics. Tube diameter is normally given for a fibre angle of $\pm 45^\circ$ but the braiding process allows the fibres to move between angles of about 25° and 75° , depending on the number and tex of the fibres. The narrow angle gives a small diameter whereas the wider angle gives a large diameter. Therefore along the length of one tube it is possible to change the diameter by variation of the fibre angle - a smaller angle (relative to zero) giving a smaller diameter and vice versa. Braids can be found in such composite components as masts, antennae, drive shafts and other tubular structures that require torsional strength.



Core Materials

Introduction

Engineering theory shows that the flexural stiffness of any panel is proportional to the cube of its thickness. The purpose of a core in a composite laminate is therefore to increase the laminate's stiffness by effectively 'thickening' it with a low-density core material. This can provide a dramatic increase in stiffness for very little additional weight.

Fig.32 shows a cored laminate under a bending load. Here, the sandwich laminate can be likened to an I-beam, in which the laminate skins act as the I-beam flange, and the core materials act as the beam's shear web. In this mode of loading it can be seen that the upper skin is put into compression, the lower skin into tension and the core into shear. It therefore follows that one of the most important properties of a core is its shear strength and stiffness.

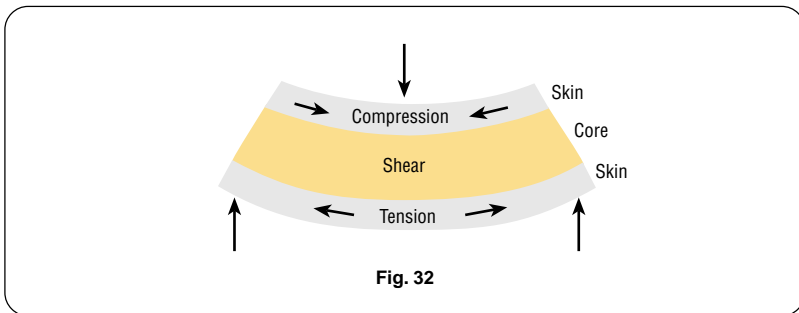

In addition, particularly when using lightweight, thin laminate skins, the core must be capable of taking a compressive loading without premature failure. This helps to prevent the thin skins from wrinkling, and failing in a buckling mode.

Core Types

Foam Cores

Foams are one of the most common forms of core material. They can be manufactured from a variety of synthetic polymers including polyvinyl chloride (PVC), polystyrene (PS), polyurethane (PU), polymethyl methacrylamide (acrylic), polyetherimide (PEI) and styreneacrylonitrile (SAN). They can be supplied in densities ranging from less than 30kg/m³ to more than 300kg/m³, although the most used densities for composite structures range from 40 to 200 kg/m³. They are also available in a variety of thicknesses, typically from 5mm to 50mm.



PVC Foam

Closed-cell polyvinyl chloride (PVC) foams are one of the most commonly used core materials for the construction of high performance sandwich structures. Although strictly they are a chemical hybrid of PVC and polyurethane, they tend to be referred to simply as 'PVC foams'.

PVC foams offer a balanced combination of static and dynamic properties and good resistance to water absorption. They also have a large operating temperature range of typically -240°C to +80°C (-400°F to +180°F), and are resistant to many chemicals. Although PVC foams are generally flammable, there are fire-retardant grades that can be used in many fire-critical applications, such as train components. When used as a core for sandwich construction with FRP skins, its reasonable resistance to styrene means that it can be used safely with polyester resins and it is therefore popular in many industries. It is normally supplied in sheet form, either plain, or grid-scored to allow easy forming to shape.

There are two main types of PVC foam: crosslinked and uncrosslinked with the uncrosslinked foams sometimes being referred to as 'linear'. The uncrosslinked foams (such as Airex R63.80) are tougher and more flexible, and are easier to heat-form around curves. However, they have some lower mechanical properties than an equivalent density of cross-linked PVC, and a lower resistance to elevated temperatures and styrene. Their cross-linked counterparts are harder but more brittle and will produce a stiffer panel, less susceptible to softening or creeping in hot climates. Typical cross-linked PVC products include the Herex C-series of foams, Divinycell H and HT grades and Polimex Klegecell and Termanto products.

A new generation of toughened PVC foams is now also becoming available which trade some of the basic mechanical properties of the cross-linked PVC foams for some of the improved toughness of the linear foams. Typical products include Divinycell HD grade.

Owing to the nature of the PVC/polyurethane chemistry in cross-linked PVC foams, these materials need to be thoroughly sealed with a resin coating before they can be safely used with low-temperature curing prepregs. Although special heat stabilisation treatments are available for these foams, these treatments are primarily designed to improve the dimensional stability of the foam, and reduce the amount of gassing that is given off during elevated temperature processing.

Polystyrene Foams

Although polystyrene foams are used extensively in sail and surf board manufacture, where their light weight (40kg/m³), low cost and easy to sand characteristics are of prime importance, they are rarely employed in high performance component construction because of their low mechanical properties. They cannot be used in conjunction with polyester resin systems because they will be dissolved by the styrene present in the resin.

Polyurethane Foams

Polyurethane foams exhibit only moderate mechanical properties and have a tendency for the foam surface at the resin/core interface to deteriorate with age, leading to skin delamination. Their structural applications are therefore normally limited to the

production of formers to create frames or stringers for stiffening components. However, polyurethane foams can be used in lightly loaded sandwich panels, with these panels being widely used for thermal insulation. The foam also has reasonable elevated service temperature properties (150°C/300°F), and good acoustic absorption. The foam can readily be cut and machined to required shapes or profiles.

Polymethyl methacrylamide Foams

For a given density, polymethyl methacrylamide (acrylic) foams such as Rohacell offer some of the highest overall strengths and stiffnesses of foam cores. Their high dimensional stability also makes them unique in that they can readily be used with conventional elevated temperature curing prepregs. However, they are expensive, which means that their use tends to be limited to aerospace composite parts such as helicopter rotor blades, and aircraft flaps.

Styrene acrylonitrile (SAN) co-polymer Foams

SAN foams behave in a similar way to toughened cross-linked PVC foams. They have most of the static properties of cross-linked PVC cores, yet have much higher elongations and toughness. They are therefore able to absorb impact levels that would fracture both conventional and even the toughened PVC foams. However, unlike the toughened PVC's, which use plasticizers to toughen the polymer, the toughness properties of SAN are inherent in the polymer itself, and so do not change appreciably with age.

SAN foams are replacing linear PVC foams in many applications since they have much of the linear PVC's toughness and elongation, yet have a higher temperature performance and better static properties. However, they are still thermoformable, which helps in the manufacture of curved parts. Heat-stabilised grades of SAN foams can also be more simply used with low-temperature curing prepregs, since they do not have the interfering chemistry inherent in the PVC's. Typical SAN products include SP's Core-Cell® A-series foams.

Other thermoplastics

As new techniques develop for the blowing of foams from thermoplastics, the range of expanded materials of this type continues to increase. Typical is PEI foam, an expanded polyetherimide/polyether sulphone, which combines outstanding fire performance with high service temperature. Although it is expensive, this foam can be used in structural, thermal and fire protection applications in the service temperature range -194°C (-320°F) to +180°C (+355°F). It is highly suitable for aircraft and train interiors, as it can meet some of the most stringent fire resistant specifications.

Honeycombs

Honeycomb cores are available in a variety of materials for sandwich structures. These range from paper and card for low strength and stiffness, low load applications (such as domestic internal doors) to high strength and stiffness, extremely lightweight components for aircraft structures. Honeycombs can be processed into both flat and curved composite structures, and can be made to conform to compound curves without excessive mechanical force or heating.



Thermoplastic honeycombs are usually produced by extrusion, followed by slicing to thickness. Other honeycombs (such as those made of paper and aluminium) are made by a multi-stage process. In these cases large thin sheets of the material (usually 1.2x2.4m) are printed with alternating, parallel, thin stripes of adhesive and the sheets are then stacked in a heated press while the adhesive cures. In the case of aluminium honeycomb the stack of sheets is then sliced through its thickness. The slices (known as 'block form') are later gently stretched and expanded to form the sheet of continuous hexagonal cell shapes.

In the case of paper honeycombs, the stack of bonded paper sheets is gently expanded to form a large block of honeycomb, several feet thick. Held in its expanded form, this fragile paper honeycomb block is then dipped in a tank of resin, drained and cured in an oven. Once this dipping resin has cured, the block has sufficient strength to be sliced into the final thicknesses required.

In both cases, by varying the degree of pull in the expansion process, regular hexagon-shaped cells or over-expanded (elongated) cells can be produced, each with different mechanical and handling/drape properties. Due to this bonded method of construction, a honeycomb will have different mechanical properties in the 0° and 90° directions of the sheet.

While skins are usually of FRP, they may be almost any sheet material with the appropriate properties, including wood, thermoplastics (eg melamine) and sheet metals, such as aluminium or steel. The cells of the honeycomb structure can also be filled with a rigid foam. This provides a greater bond area for the skins, increases the mechanical properties of the core by stabilising the cell walls and increases thermal and acoustic insulation properties.

Properties of honeycomb materials depend on the size (and therefore frequency) of the cells and the thickness and strength of the web material. Sheets can range from typically 3-50 mm in thickness and panel dimensions are typically 1200 x 2400mm, although it is possible to produce sheets up to 3m x 3m.

Honeycomb cores can give stiff and very light laminates but due to their very small bonding area they are almost exclusively used with high-performance resin systems such as epoxies so that the necessary adhesion to the laminate skins can be achieved.

Aluminium honeycomb

Aluminium honeycomb produces one of the highest strength/weight ratios of any structural material. There are various configurations of the adhesive-bonding of the aluminium foil which can lead to a variety of geometric cell shapes (usually hexagonal). Properties can also be controlled by varying the foil thickness and cell size. The honeycomb is usually supplied in the unexpanded block form and is stretched out into a sheet on-site.

Despite its good mechanical properties and relatively low price, aluminium honeycomb has to be used with caution in some applications, such as large marine structures, because of the potential corrosion problems in a salt-water environment. In this situation care also has to be exercised to ensure that the honeycomb does not come into direct contact with carbon skins since the conductivity can aggravate galvanic corrosion. Aluminium honeycomb also has the problem that it has no 'mechanical

memory'. On impact of a cored laminate, the honeycomb will deform irreversibly whereas the FRP skins, being resilient, will move back to their original position. This can result in an area with an unbonded skin with much reduced mechanical properties.

Nomex honeycomb

Nomex honeycomb is made from Nomex paper - a form of paper based on Kevlar™, rather than cellulose fibres. The initial paper honeycomb is usually dipped in a phenolic resin to produce a honeycomb core with high strength and very good fire resistance. It is widely used for lightweight interior panels for aircraft in conjunction with phenolic resins in the skins. Special grades for use in fire retardant applications (eg public transport interiors) can also be made which have the honeycomb cells filled with phenolic foam for added bond area and insulation.

Nomex honeycomb is becoming increasingly used in high-performance non-aerospace components due to its high mechanical properties, low density and good long-term stability. However, as can be seen from Fig.33, it is considerably more expensive than other core materials.

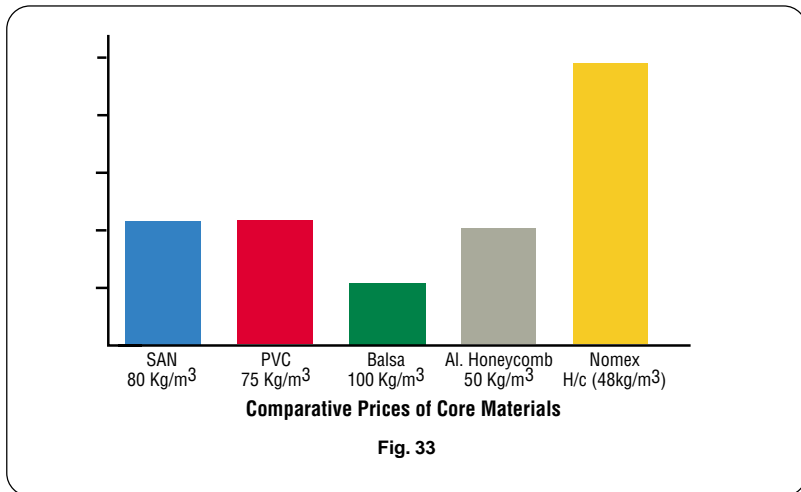

Thermoplastic honeycomb

Core materials made of other thermoplastics are light in weight, offering some useful properties and possibly also making for easier recycling. Their main disadvantage is the difficulty of achieving a good interfacial bond between the honeycomb and the skin material, and their relatively low stiffness. Although they are rarely used in highly loaded structures, they can be useful in simple interior panels. The most common polymers used are:

ABS - for rigidity, impact strength, toughness, surface hardness and dimensional stability

Polycarbonate - for UV-stability, excellent light transmission, good heat resistance & self-extinguishing properties

Polypropylene - for good chemical resistance

Polyethylene - a general-purpose low-cost core material

Wood

Wood can be described as 'nature's honeycomb', as it has a structure that, on a microscopic scale, is similar to the cellular hexagonal structure of synthetic honeycomb. When used in a sandwich structure with the grain running perpendicular to the plane of the skins, the resulting component shows properties similar to those made with man-made honeycombs. However, despite various chemical treatments being available, all wood cores are susceptible to moisture attack and will rot if not well surrounded by laminate or resin.

Balsa

The most commonly used wood core is end-grain balsa. Balsa wood cores first appeared in the 1940's in flying boat hulls, which were aluminium skinned and balsa-cored to withstand the repeated impact of landing on water. This performance led the marine industry to begin using end-grain balsa as a core material in FRP construction. Apart from its high compressive properties, its advantages include being a good thermal insulator offering good acoustic absorption. The material will not deform when heated and acts as an insulating and ablative layer in a fire, with the core charring slowly, allowing the non-exposed skin to remain structurally sound. It also offers positive flotation and is easily worked with simple tools and equipment.

Balsa core is available as contoured end-grain sheets 3 to 50mm thick on a backing fabric, and rigid end-grain sheets up to 100mm thick. These sheets can be provided ready resin-coated for vacuum-bagging, prepreg or pressure-based manufacturing processes such as RTM. One of the disadvantages of balsa is its high minimum density, with 100kg/m³ being a typical minimum. This problem is exacerbated by the fact that balsa can absorb large quantities of resin during lamination, although pre-sealing the foam can reduce this. Its use is therefore normally restricted to projects where optimum weight saving is not required or in locally highly stressed areas.

Cedar

Another wood that is used sometimes as a core material is cedar. In marine construction it is often the material used as the 'core' in strip-plank construction, with a composite skin on each side and the grain of the cedar running parallel to the laminate faces. The cedar fibres run along the length of the boat giving fore and aft stiffness while the fibres in the FRP skins are laid at $\pm 45^\circ$ giving torsional rigidity, and protecting the wood.

Other Core Materials

Although not usually regarded as true sandwich cores, there are a number of thin, low-density 'fabric-like' materials which can be used to slightly lower the density of a single-skin laminate. Materials such as Coremat™ and Spheretex™ consist of a non-woven 'felt-like' fabric full of density-reducing hollow spheres. They are usually only 1-3mm in thickness and are used like another layer of reinforcement in the middle of a laminate, being designed to 'wet out' with the laminating resin during construction. However, the hollow spheres displace resin and so the resultant middle layer, although

much heavier than a foam or honeycomb core, is lower in density than the equivalent thickness of glass fibre laminate. Being so thin they can also conform easily to 2-D curvature, and so are quick and easy to use.

Comparison of Core Mechanical Properties

Figs. 34 and 35 give the shear strength and compressive strength of some of the core materials described, plotted against their densities. All the figures have been obtained from manufacturers' data sheets.

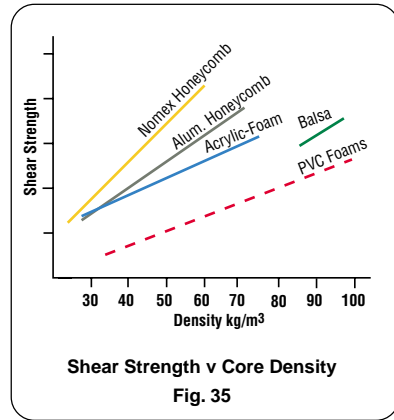
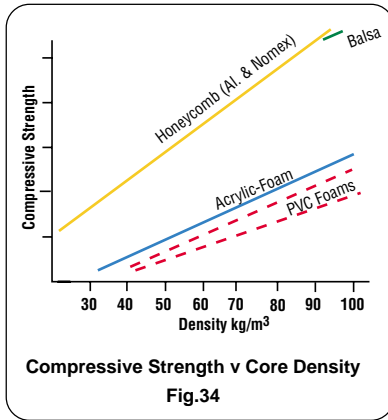

As might be expected, all the cores show an increase in properties with increasing density. However, other factors, besides density, also come into play when looking at the weight of a core in a sandwich structure. For example, low density foam materials, while contributing very little to the weight of a sandwich laminate, often have a very open surface cell structure which can mean that a large mass of resin is absorbed in their bondlines. The lower the density of the foam, the larger are the cells and the worse is the problem. Honeycombs, on the other hand, can be very good in this respect since a well formulated adhesive will form a small bonding fillet only around the cell walls (see Fig.36).

Finally, consideration needs to be given to the form a core is used in to ensure that it fits the component well. The weight savings that cores can offer can quickly be used up if cores fit badly, leaving large gaps that require filling with adhesive. Scrim-backed foam or balsa, where little squares of the core are supported on a lightweight scrim cloth, can be used to help cores conform better to a curved surface. Contour-cut foam, where slots are cut part-way through the core from opposite sides achieves a similar effect. However, both these cores still tend to use quite large amounts of adhesive since the slots between each foam square need filling with resin to produce a good structure.

In weight-critical components the use of foam cores which are thermoformable should be considered. These include the linear PVC's and the SAN foams which can all be heated to above their softening points and pre-curved to fit a mould shape.

For honeycombs, over-expanded forms are the most widely used when fitting the core to a compound curve, since with different expansion patterns a wide range of conformability can be achieved.

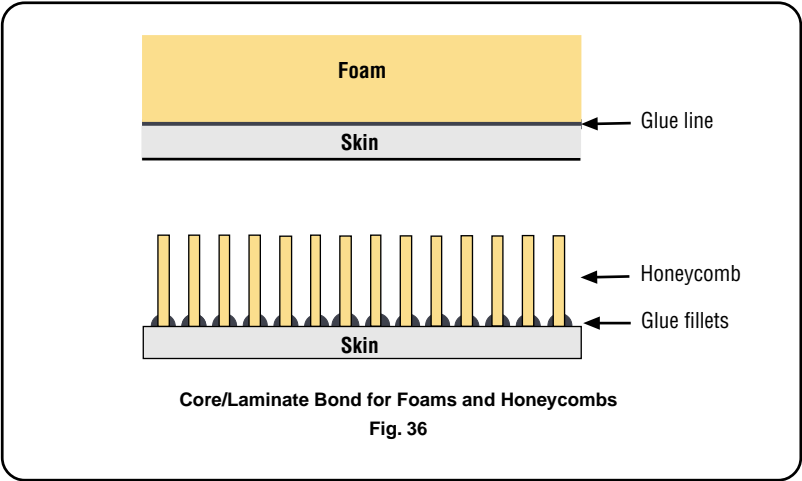

Cores - Properties

Property	Test	Unit	Core-cell® foam	Linear PVC foam	Cross-linked PVC foam low density	Cross-linked PVC foam high density
Apparent nominal density	ISO 945	kg/m ³	50-200*	50-80	40-80	100-200
	D 1622	lb/ft ³	3.5-12.5	3.1-5.0	2.5-5.0	6.25-12.5
Compressive strength	ISO 844	N/mm ²		0.4-0.9	0.5-1.4	2.0-4.6
	D 1621	psi	63-584	60-130	70-200	290-667
Tensile strength	DIN 53455	N/mm ²		1.2-1.8	0.5-1.9	2.6-6.0
	C 297	psi	150-468	165-260	75-230	340-87
Flexural strength	DIN 53455 D 790	N/mm ² psi	173-1024			
Shear strength	ISO 1922	N/mm ²		0.5-1.2	0.4-1.2	1.6-3.5
	C 273	psi	96-286	70-170	60-160	220-508
E-modulus compression	DIN 53457	N/mm ²		37-56	26-75	110-223
	D 1621	psi	2132-18408	5365-8120	3900-10850	15950-3234
E-modulus tensile	DIN53457	N/mm ²		37-64	29-57	80-188
	D 1621	psi		5365-9280	4200-9700	12300-2727
E-modulus flexural	DIN53457 D 790	N/mm ² psi	7458-42441			
Shear modulus	ASTM C 393	N/mm ²		15-21	12-30	38-77
		psi	1699-6555	2175-3045	1750-4600	5450-11170
Shear elongation at break	ISO 1922 C273	%	60-40	80	10-30	30-31
Impact strength	DIN 53453	kJ/m ²		4.0-5.0	0.2-0.9	1.4-4.0
				1.9-2.4	0.007-0.29	0.33-1.01
Thermal conductivity	DIN 52612	W/m K		0.033-0.035	0.029-0.033	0.038-0.042
	C 177			0.229-0.243	0.19-0.23	
Maximum operating temperature	DIN 53445	°C		55-60	65-75	80
		°F		130-140	149-167	176
Water absorption 7 day	DIN 53428	Vol.%				

* Density quoted is for A foam only. Also available in S foam with a density of 100 to 300.

Copolymer foam high density	PU rigid foam closed-cell	PEI/PES foam	Aluminium honeycomb lengthways	Aluminium honeycomb widthways	Aramid honeycomb lengthways	Aramid honeycomb widthways
200-400 12.5-25	60 3.7	80 5				
4.0-13.0 580-1885	0.42 61	0.75 110	4.2		620-73	125-1870
		1.9 276				
3.0-8.0 435-1160	0.41 59	0.9 130	2.38	1.48	85-480	45-395
155-350 22480-37600	20 2900	45 6530	148-16		6-90	
		52 7540				
60-240 8700-34810	4.1 595	18 2610	63-14	31-7	3.7-17	2.0-9.0
7-6	30	30				
1.40-4.60 0.71-2.34	0.9 0.4	1.6 0.4				
0.048-0.055 0.333-0.382	0.030 0.208	0.035				
80 200	150 300	190 375				
		2.3				

Manufacturing Processes

Introduction

Taking composite materials as a whole, there are many different material options to choose from in the areas of resins, fibres and cores, all with their own unique set of properties such as strength, stiffness, toughness, heat resistance, cost, production rate etc.. However, the end properties of a composite part produced from these different materials is not only a function of the individual properties of the resin matrix and fibre (and in sandwich structures, the core as well), but is also a function of the way in which the materials themselves are designed into the part and also the way in which they are processed. This section compares a few of the commonly used composite production methods and presents some of the factors to be borne in mind with each different process, including the influence of each process on materials selection.

Comparison of Processes

Spray Lay-up

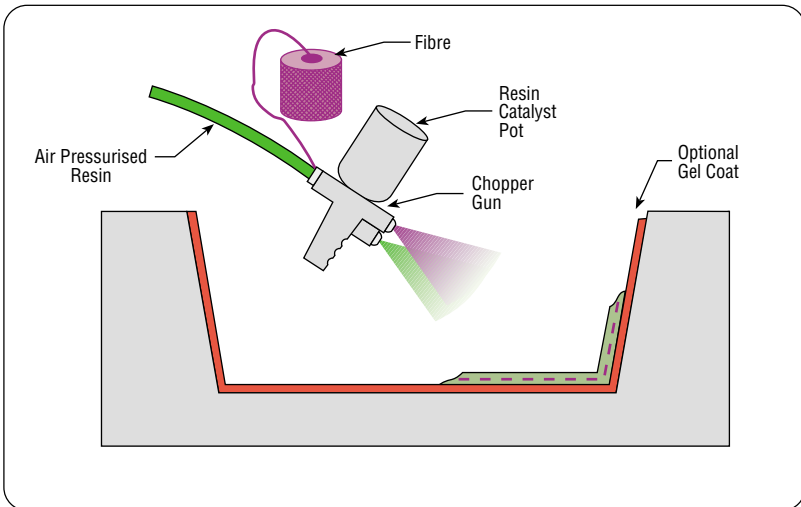

Description

Fibre is chopped in a hand-held gun and fed into a spray of catalysed resin directed at the mould. The deposited materials are left to cure under standard atmospheric conditions.

Materials Options:

Resins: Primarily polyester.

Fibres: Glass roving only.

Cores: None. These have to be incorporated separately.

Main Advantages:

- i) Widely used for many years.
- ii) Low cost way of quickly depositing fibre and resin.
- iii) Low cost tooling.

Main Disadvantages:

- i) Laminates tend to be very resin-rich and therefore excessively heavy.
- ii) Only short fibres are incorporated which severely limits the mechanical properties of the laminate.
- iii) Resins need to be low in viscosity to be sprayable. This generally compromises their mechanical/thermal properties.
- iv) The high styrene contents of spray lay-up resins generally means that they have the potential to be more harmful and their lower viscosity means that they have an increased tendency to penetrate clothing etc.
- (v) Limiting airborne styrene concentrations to legislated levels is becoming increasingly difficult.

Typical Applications:

Simple enclosures, lightly loaded structural panels, e.g. caravan bodies, truck fairings, bathtubs, shower trays, some small dinghies.

Wet Lay-up/Hand Lay-up

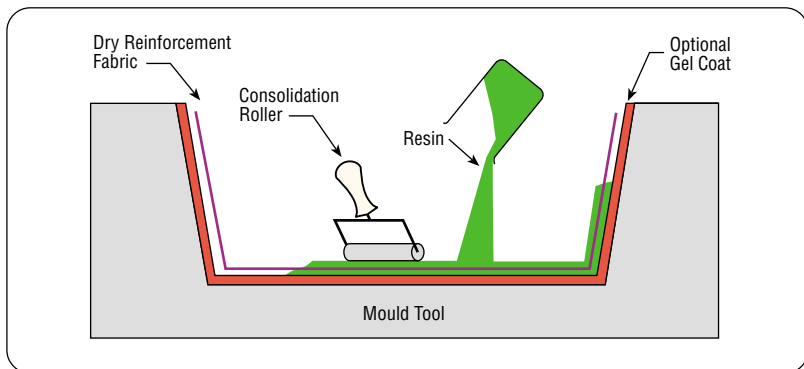

Description

Resins are impregnated by hand into fibres which are in the form of woven, knitted, stitched or bonded fabrics. This is usually accomplished by rollers or brushes, with an increasing use of nip-roller type impregnators for forcing resin into the fabrics by means of rotating rollers and a bath of resin. Laminates are left to cure under standard atmospheric conditions.

Materials Options:

Resins: Any, e.g. epoxy, polyester, vinylester, phenolic.

Fibres: Any, although heavy aramid fabrics can be hard to wet-out by hand.

Cores: Any.

Main Advantages:

- i) Widely used for many years.
- ii) Simple principles to teach.
- iii) Low cost tooling, if room-temperature cure resins are used.
- iv) Wide choice of suppliers and material types.
- v) Higher fibre contents, and longer fibres than with spray lay-up.

Main Disadvantages:

- i) Resin mixing, laminate resin contents, and laminate quality are very dependent on the skills of laminators. Low resin content laminates cannot usually be achieved without the incorporation of excessive quantities of voids.
- ii) Health and safety considerations of resins. The lower molecular weights of hand lay-up resins generally means that they have the potential to be more harmful than higher molecular weight products. The lower viscosity of the resins also means that they have an increased tendency to penetrate clothing etc.
- iii) Limiting airborne styrene concentrations to legislated levels from polyesters and vinylesters is becoming increasingly hard without expensive extraction systems.
- iv) Resins need to be low in viscosity to be workable by hand. This generally compromises their mechanical/thermal properties due to the need for high diluent/styrene levels.

Typical Applications:

Standard wind-turbine blades, production boats, architectural mouldings.

Vacuum Bagging

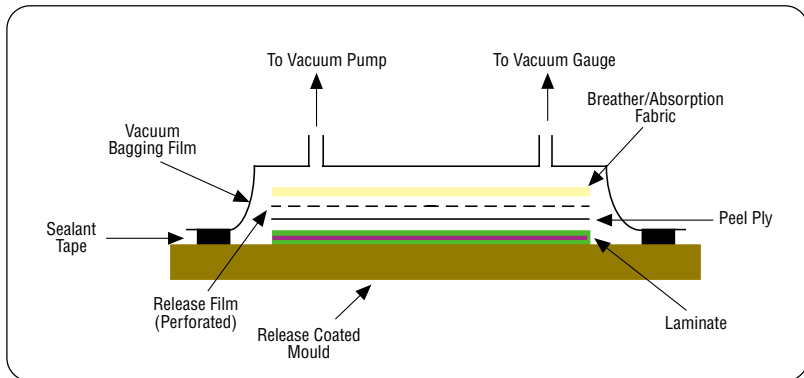

Description

This is basically an extension of the wet lay-up process described above where pressure is applied to the laminate once laid-up in order to improve its consolidation. This is achieved by sealing a plastic film over the wet laid-up laminate and onto the tool. The air under the bag is extracted by a vacuum pump and thus up to one atmosphere of pressure can be applied to the laminate to consolidate it.

Materials Options:

- Resins: Primarily epoxy and phenolic. Polyesters and vinylesters may have problems due to excessive extraction of styrene from the resin by the vacuum pump.
- Fibres: The consolidation pressures mean that a variety of heavy fabrics can be wet-out.
- Cores: Any.

Main Advantages:

- i) Higher fibre content laminates can usually be achieved than with standard wet lay-up techniques.
- ii) Lower void contents are achieved than with wet lay-up.
- iii) Better fibre wet-out due to pressure and resin flow throughout structural fibres, with excess into bagging materials.
- iv) Health and safety: The vacuum bag reduces the amount of volatiles emitted during cure.

Main Disadvantages:

- i) The extra process adds cost both in labour and in disposable bagging materials
- ii) A higher level of skill is required by the operators
- iii) Mixing and control of resin content still largely determined by operator skill

Typical Applications:

Large, one-off cruising boats, racecar components, core-bonding in production boats.

Filament Winding

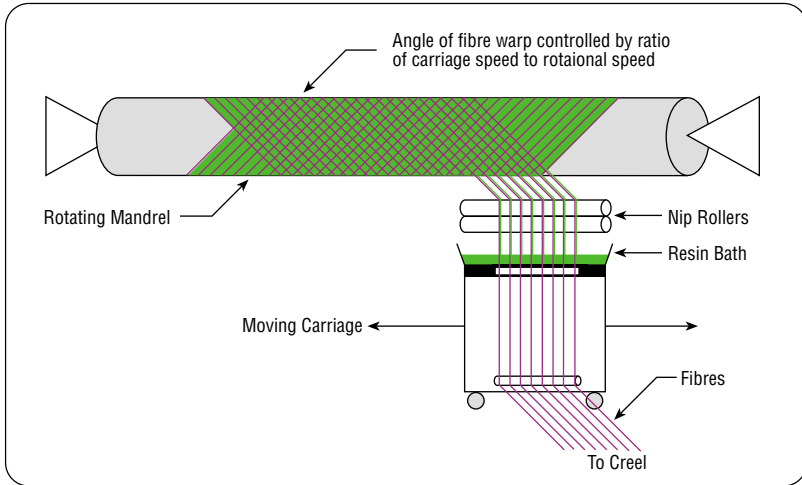

Description

This process is primarily used for hollow, generally circular or oval sectioned components, such as pipes and tanks. Fibre tows are passed through a resin bath before being wound onto a mandrel in a variety of orientations, controlled by the fibre feeding mechanism, and rate of rotation of the mandrel.

Materials Options:

Resins: Any, e.g. epoxy, polyester, vinylester, phenolic.

Fibres: Any. The fibres are used straight from a creel and not woven or stitched into a fabric form.

Cores: Any, although components are usually single skin.

Main Advantages:

- i) This can be a very fast and therefore economic method of laying material down.
- ii) Resin content can be controlled by metering the resin onto each fibre tow through nips or dies.
- iii) Fibre cost is minimised since there is no secondary process to convert fibre into fabric prior to use.
- iv) Structural properties of laminates can be very good since straight fibres can be laid in a complex pattern to match the applied loads.

Main Disadvantages:

- i) The process is limited to convex shaped components.
- ii) Fibre cannot easily be laid exactly along the length of a component.
- iii) Mandrel costs for large components can be high.
- iv) The external surface of the component is unmoulded, and therefore cosmetically unattractive.

- v) Low viscosity resins usually need to be used with their attendant lower mechanical and health and safety properties.

Typical Applications:

Chemical storage tanks and pipelines, gas cylinders, fire-fighters breathing tanks.

Pultrusion

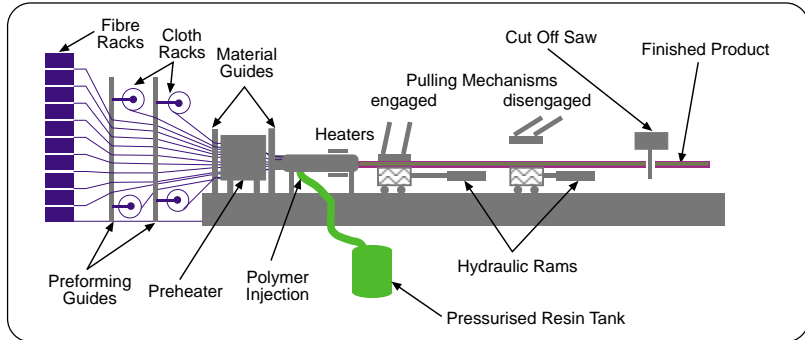

Description

Fibres are pulled from a creel through a resin bath and then on through a heated die. The die completes the impregnation of the fibre, controls the resin content and cures the material into its final shape as it passes through the die. This cured profile is then automatically cut to length. Fabrics may also be introduced into the die to provide fibre direction other than at 0° . Although pultrusion is a continuous process, producing a profile of constant cross-section, a variant known as 'pulforming' allows for some variation to be introduced into the cross-section. The process pulls the materials through the die for impregnation, and then clamps them in a mould for curing. This makes the process non-continuous, but accommodating of small changes in cross-section.

Materials Options:

Resins: Generally epoxy, polyester, vinylester and phenolic.

Fibres: Any.

Cores: Not generally used.

Main Advantages:

- i) This can be a very fast, and therefore economic, way of impregnating and curing materials.
- ii) Resin content can be accurately controlled.
- iii) Fibre cost is minimised since the majority is taken from a creel.
- iv) Structural properties of laminates can be very good since the profiles have very straight fibres and high fibre volume fractions can be obtained.
- v) Resin impregnation area can be enclosed thus limiting volatile emissions.

Main Disadvantages:

- i) Limited to constant or near constant cross-section components
- ii) Heated die costs can be high.

Typical Applications:

Beams and girders used in roof structures, bridges, ladders, frameworks.

Resin Transfer Moulding (RTM)

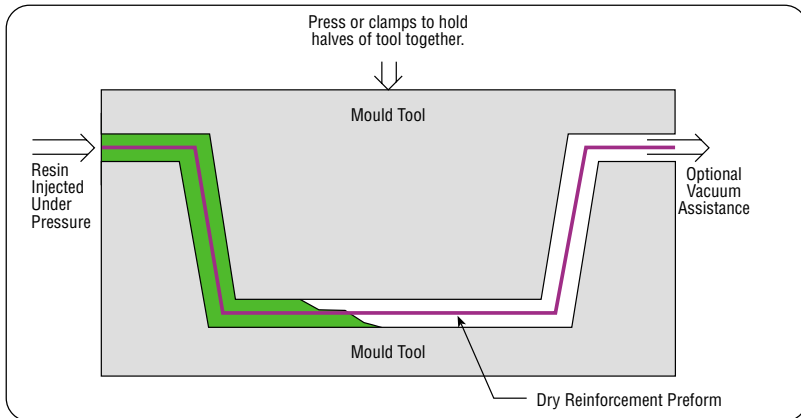

Description

Fabrics are laid up as a dry stack of materials. These fabrics are sometimes pre-pressed to the mould shape, and held together by a binder. These 'preforms' are then more easily laid into the mould shape. A second mould tool is then clamped over the first, and resin is injected into the cavity. Vacuum can also be applied to the mould cavity to assist resin in being drawn into the fabrics. This is known as Vacuum Assisted Resin Injection (VARI). Once all the fabric is wet out, the resin inlets are closed, and the laminate is allowed to cure. Both injection and cure can take place at either ambient or elevated temperature.

Materials Options:

- Resins: Generally epoxy, polyester, vinylester and phenolic, although high temperature resins such as bismaleimides can be used at elevated process temperatures.
- Fibres: Any. Stitched materials work well in this process since the gaps allow rapid resin transport. Some specially developed fabrics can assist with resin flow.
- Cores: Not honeycombs, since cells would fill with resin, and pressures involved can crush some foams.

Main Advantages:

- i) High fibre volume laminates can be obtained with very low void contents.
- ii) Good health and safety, and environmental control due to enclosure of resin.

- iii) Possible labour reductions.
- iv) Both sides of the component have a moulded surface.

Main Disadvantages:

- i) Matched tooling is expensive, and heavy in order to withstand pressures.
- ii) Generally limited to smaller components.
- iii) Unimpregnated areas can occur resulting in very expensive scrap parts.

Typical Applications:

Small complex aircraft and automotive components, train seats.

Other Infusion Processes - SCRIMP, RIFT, VARTM etc.

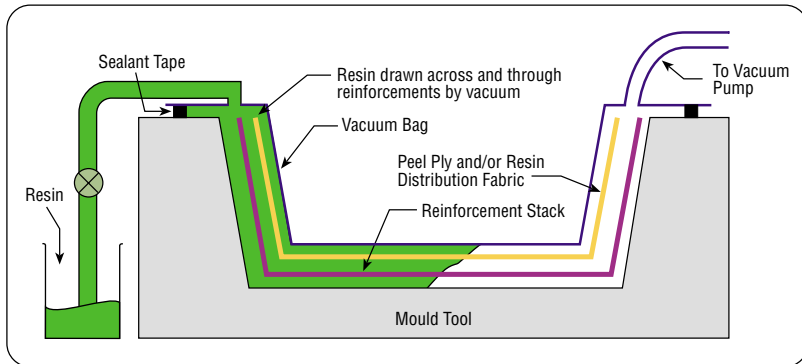

Description

Fabrics are laid up as a dry stack of materials as in RTM. The fibre stack is then covered with peel ply and a knitted type of non-structural fabric. The whole dry stack is then vacuum bagged, and once bag leaks have been eliminated, resin is allowed to flow into the laminate. The resin distribution over the whole laminate is aided by resin flowing easily through the non-structural fabric, and wetting the fabric out from above.

Materials Options:

- Resins: Generally epoxy, polyester and vinylester.
- Fibres: Any conventional fabrics. Stitched materials work well in this process since the gaps allow rapid resin transport.
- Cores: Any except honeycombs.

Main Advantages:

- i) As RTM above, except only one side of the component has a moulded finish.
- ii) Much lower tooling cost due to one half of the tool being a vacuum bag, and less strength being required in the main tool.
- iii) Large components can be fabricated.

- iv) Standard wet lay-up tools may be able to be modified for this process.
- v) Cored structures can be produced in one operation.

Main Disadvantages:

- i) Relatively complex process to perform well.
- ii) Resins must be very low in viscosity, thus comprising mechanical properties.
- iii) Unimpregnated areas can occur resulting in very expensive scrap parts.
- iv) Some elements of this process are covered by patents (SCRIMP).

Typical Applications:

Semi-production small yachts, train and truck body panels.

Prepregs

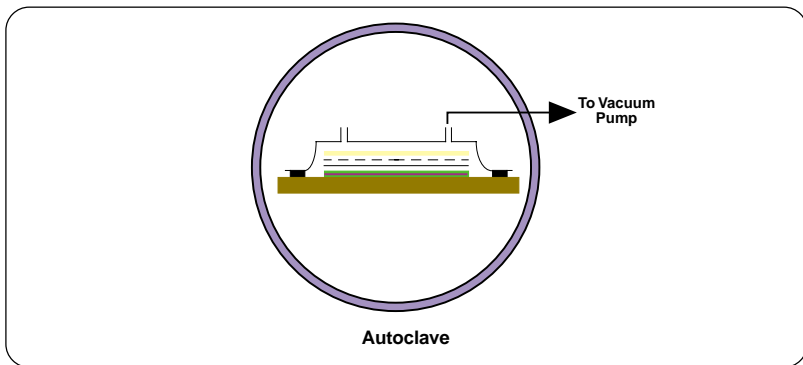

Description

Fabrics and fibres are pre-impregnated by the materials manufacturer, under heat and pressure or with solvent, with a pre-catalysed resin. The catalyst is largely latent at ambient temperatures giving the materials several weeks, or sometimes months, of useful life when defrosted. However to prolong storage life the materials are stored frozen. The resin is usually a near-solid at ambient temperatures, and so the pre-impregnated materials (prepregs) have a light sticky feel to them, such as that of adhesive tape. Unidirectional materials take fibre direct from a creel, and are held together by the resin alone. The prepregs are laid up by hand or machine onto a mould surface, vacuum bagged and then heated to typically 120-180°C. This allows the resin to initially reflow and eventually to cure. Additional pressure for the moulding is usually provided by an autoclave (effectively a pressurised oven) which can apply up to 5 atmospheres to the laminate.

Materials Options:

Resins: Generally epoxy, polyester, phenolic and high temperature resins such as polyimides, cyanate esters and bismaleimides.

Fibres: Any. Used either direct from a creel or as any type of fabric.

Cores: Any, although special types of foam need to be used due to the elevated temperatures involved in the process.

Main Advantages:

- i) Resin/catalyst levels and the resin content in the fibre are accurately set by the materials manufacturer. High fibre contents can be safely achieved.
- ii) The materials have excellent health and safety characteristics and are clean to work with.
- iii) Fibre cost is minimised in unidirectional tapes since there is no secondary process to convert fibre into fabric prior to use.
- iv) Resin chemistry can be optimised for mechanical and thermal performance, with the high viscosity resins being impregnable due to the manufacturing process.
- v) The extended working times (of up to several months at room temperatures) means that structurally optimised, complex lay-ups can be readily achieved.
- vi) Potential for automation and labour saving.

Main Disadvantages:

- i) Materials cost is higher for preimpregnated fabrics.
- ii) Autoclaves are usually required to cure the component. These are expensive, slow to operate and limited in size.
- iii) Tooling needs to be able to withstand the process temperatures involved
- iv) Core materials need to be able to withstand the process temperatures and pressures.

Typical Applications:

Aircraft structural components (e.g. wings and tail sections), F1 racing cars, sporting goods such as tennis racquets and skis.

Low Temperature Curing Prepregs

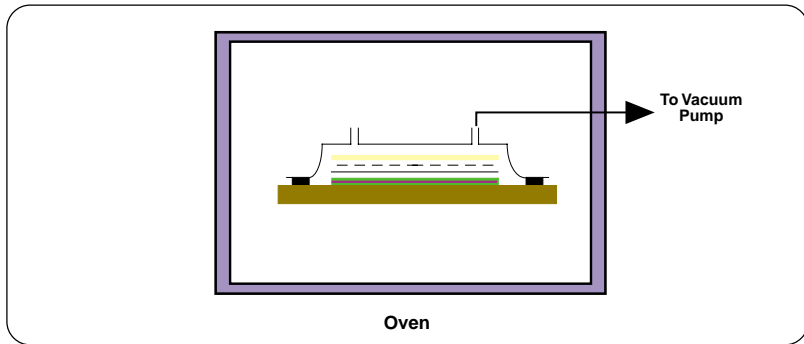

Description

Low Temperature Curing prepregs are made exactly as conventional prepregs but have resin chemistries that allow cure to be achieved at temperatures from 60-100°C. At 60°C, the working life of the material may be limited to as little as a week, but above this working times can be as long as several months. The flow profiles of the resin systems allow for the use of vacuum bag pressures alone, avoiding the need for autoclaves.

Materials Options:

Resins: Generally only epoxy.

Fibres: Any. As for conventional prepregs.

Cores: Any, although standard PVC foam needs special care.

Main Advantages:

- i) All of the advantages ((i)-(vi)) associated with the use of conventional prepregs are incorporated in low-temperature curing prepregs.
- ii) Cheaper tooling materials, such as wood, can be used due to the lower cure temperatures involved.
- iii) Large structures can be readily made since only vacuum bag pressure is required, and heating to these lower temperatures can be achieved with simple hot-air circulated ovens, often built in-situ over the component.
- iv) Conventional PVC foam core materials can be used, providing certain procedures are followed.
- v) Lower energy cost.

Main Disadvantages:

- i) Materials cost is still higher than for non-preimpregnated fabrics.
- ii) An oven and vacuum bagging system is required to cure the component.
- iii) Tooling needs to be able to withstand above-ambient temperatures involved (typically 60-100°C).
- iv) Still an energy cost associated with above-ambient cure temperature.

Typical Applications:

High-performance wind-turbine blades, large racing and cruising yachts, rescue craft, train components.

Resin Film Infusion (RFI)

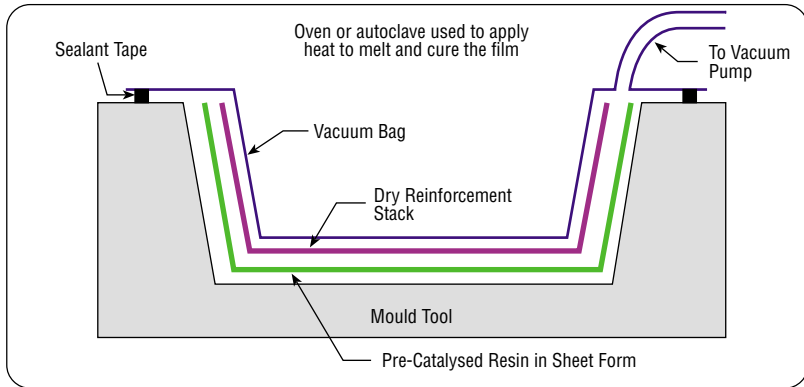

Description

Dry fabrics are laid up interleaved with layers of semi-solid resin film supplied on a release paper. The lay-up is vacuum bagged to remove air through the dry fabrics, and then heated to allow the resin to first melt and flow into the air-free fabrics, and then after a certain time, to cure.

Materials Options:

Resins: Generally epoxy only.

Fibres: Any.

Cores: Most, although PVC foam needs special procedures due to the elevated temperatures involved in the process.

Main Advantages:

- i) High fibre volumes can be accurately achieved with low void contents.
- ii) Good health and safety and a clean lay-up, like prepreg.
- iii) High resin mechanical properties due to solid state of initial polymer material and elevated temperature cure.
- iv) Potentially lower cost than prepreg, with most of the advantages.
- v) Less likelihood of dry areas than SCRIMP process due to resin travelling through fabric thickness only.

Main Disadvantages:

- i) Not widely proven outside the aerospace industry.
- ii) An oven and vacuum bagging system is required to cure the component as for prepreg, although the autoclave systems used by the aerospace industry are not always required.
- iii) Tooling needs to be able to withstand the process temperatures of the resin film (which if using similar resin to those in low-temperature curing prepregs, is typically 60-100°C).
- iv) Core materials need to be able to withstand the process temperatures and pressures.

Typical Applications:

Aircraft radomes and submarine sonar domes.

Estimating Quantities of SP Formulated Products

Laminating Resins

$$\text{Resin/ Hardener Mix Required (g)} = \frac{A \times n \times W_f \times R.C.}{(1 - R.C.)} \times 1.5^*$$

Where: A = Area of Laminate (sq.m)
n = Number of plies
W_f = Fibre weight of each ply (g/sq.m)
R.C. = Resin content by weight

Typical R.C.'s for hand layup manufacturing are:

Glass - 0.46
Carbon - 0.55
Aramid - 0.61

Gelcoats and Coatings

Solvent Free

$$\text{Resin/ Hardener Mix Required (kg)} = \frac{A \times t \times \rho_m}{1000} \times 1.5^*$$

Solvent Based

$$\text{Resin/ Hardener Mix Required (kg)} = \frac{A \times t \times \rho_m}{10 \times S.C.} \times 1.5^*$$

Where A = Area to be coated (sq.m)
t = Total finished thickness required (µm)
ρ_m = Density of cured resin/hardener matrix (g/cm³)
S.C. = Solids content of mix (%)

*Assuming 50% wastage, for resin residue left in mixing pots and on tools.
This wastage figure is based on SP experience of a wide variety of workshops, but should be adjusted to match local working practices.

Laminate Formulae

Fibre Volume Fraction From Densities

$$FVF = \frac{(\rho_c - \rho_m)}{(\rho_f - \rho_m)} \quad (\text{assuming zero void content})$$

Fibre Volume Fraction from Fibre Weight Fraction

$$FVF = \frac{1}{1 + \frac{\rho_f}{\rho_m} \left(\frac{1}{FWF} - 1 \right)}$$

Fibre Weight Fraction from Fibre Volume Fraction

$$FWF = \frac{\rho_f \times FVF}{\rho_m + (\rho_f - \rho_m) \times FVF}$$

Cured Ply Thickness from Ply Weight

$$CPT \text{ (mm)} = \frac{W_f}{\rho_f \times FVF \times 1000}$$

- Where
- FVF = Fibre Volume Fraction
 - FWF = Fibre Weight Fraction
 - ρ_c = Density of Composite (g/cm³)
 - ρ_m = Density of Cured Resin/ Hardener Matrix (g/cm³)
 - ρ_f = Density of Fibres (g/cm³)
 - W_f = Fibre Area Weight of each Ply (g/sqm)

Imperial/Metric Conversion Tables

For SP Products

The bold figures in the central columns can be read as either the metric or the British measure.
Thus 1 inch = 25.4 millimetres: or 1 millimetre = 0.039 inches.

<i>Mil (thou)</i>	<i>Microns</i> (μM)	<i>Inches</i>	<i>mm</i>	<i>Feet</i>	<i>Metres</i>	<i>Yards</i>	<i>Metres</i>	<i>Ounces</i>	<i>Grams</i>	<i>Pounds</i>	<i>Kilograms</i>						
0.039	1	25.40	0.039	1	25.4	3.281	1	0.305	1.094	1	0.914	0.035	1	28.350	2.205	1	0.454
0.079	2	50.80	0.079	2	50.8	6.562	2	0.610	2.187	2	1.829	0.071	2	56.699	4.409	2	0.907
0.118	3	76.20	0.118	3	76.2	9.843	3	0.914	3.281	3	2.743	0.106	3	85.048	6.614	3	1.361
0.157	4	101.60	0.157	4	101.6	13.123	4	1.219	4.374	4	3.658	0.141	4	113.398	8.818	4	1.814
0.197	5	127.00	0.197	5	127.0	16.404	5	1.524	5.468	5	4.572	0.176	5	141.748	11.023	5	2.268
0.236	6	152.40	0.236	6	152.4	19.685	6	1.829	6.562	6	5.486	0.212	6	170.097	13.228	6	2.722
0.276	7	177.80	0.276	7	177.8	22.966	7	2.134	7.655	7	6.401	0.247	7	198.446	15.432	7	3.175
0.315	8	203.20	0.315	8	203.2	26.247	8	2.438	8.749	8	7.315	0.282	8	226.796	17.637	8	3.629
0.354	9	228.60	0.354	9	228.6	29.528	9	2.743	9.843	9	8.230	0.317	9	255.146	19.842	9	4.082

<i>Fluid Oz.</i>	<i>Litres</i>	<i>Pints</i>	<i>Litres</i>	<i>US Quarts</i>	<i>Litres</i>	<i>US Gal.</i>	<i>Litres</i>	<i>Imp. Gal.</i>	<i>Litres</i>	<i>US Gal.</i>	<i>Imp. Gal.</i>						
35.21	1	0.028	1.760	1	0.568	1.057	1	0.946	0.264	1	3.785	0.220	1	4.546	1.200	1	0.833
70.42	2	0.057	3.520	2	1.137	2.114	2	1.892	0.528	2	7.570	0.440	2	9.092	2.401	2	1.666
105.63	3	0.085	5.279	3	1.705	3.171	3	2.838	0.792	3	11.355	0.660	3	13.638	3.601	3	2.499
140.84	4	0.114	7.039	4	2.273	4.228	4	3.784	1.056	4	15.140	0.880	4	18.184	4.802	4	3.332
176.06	5	0.142	8.799	5	2.841	5.285	5	4.73	1.32	5	18.925	1.100	5	22.730	6.002	5	4.165
211.27	6	0.170	10.559	6	3.410	6.342	6	5.676	1.584	6	22.710	1.320	6	27.277	7.203	6	4.998
246.48	7	0.199	12.318	7	3.978	7.400	7	6.622	1.848	7	26.495	1.540	7	31.823	8.403	7	5.831
281.69	8	0.227	14.078	8	4.546	8.457	8	7.568	2.112	8	30.280	1.760	8	36.369	9.604	8	6.664
316.90	9	0.256	15.838	9	5.114	9.514	9	8.514	2.376	9	34.065	1.980	9	40.915	10.804	9	7.497

<i>Sq. yds</i>	<i>Sq. metres</i>	<i>oz/sq.yd</i>	<i>g/sq.m</i>	<i>ksi</i>	<i>N/mm² (MPa)</i>	<i>Msi</i>	<i>Gpa</i>	$^{\circ}\text{C}$	$^{\circ}\text{F}$	$^{\circ}\text{C}$	$^{\circ}\text{F}$	
1.196	1	0.836	0.029	1	33.9	0.145	1	6.895	-18	0	115	239
2.392	2	1.672	0.059	2	67.9	0.290	2	13.790	0	32	120	248
3.588	3	2.508	0.088	3	101.8	0.435	3	20.685	5	41	125	257
4.784	4	3.345	0.118	4	135.8	0.580	4	27.580	10	50	130	266
5.980	5	4.181	0.147	5	169.7	0.725	5	34.475	15	59	135	275
7.176	6	5.017	0.177	6	203.6	0.870	6	41.370	20	68	140	284
8.372	7	5.853	0.206	7	237.6	1.015	7	48.265	25	77	145	293
9.568	8	6.689	0.236	8	271.5	1.160	8	55.160	30	86	150	302
10.764	9	7.525	0.265	9	305.5	1.305	9	62.055	35	95	155	311
									40	104	160	320
									45	113	165	329
									50	122	170	338
									55	131	175	347
									60	140	180	356
									65	149	185	365
									70	158	190	374
									75	167	195	383
									80	176	200	392
									85	185	205	401
									90	194	210	410
									95	203	215	419
									100	212	220	428
									105	221	225	437
									110	230	230	446

<i>Cu. Feet</i>	<i>Cu. Metres</i>	<i>lb/cu.in</i>	<i>g/cu.cm</i>	<i>lb/cu.ft</i>	<i>kg/cu.m</i>	<i>Miles</i>	<i>Kilomtrs.</i>				
35.315	1	0.028	0.036	1	27.7	0.062	1	16.0	0.621	1	1.609
70.629	2	0.057	0.029	0.8	22.1	0.125	2	32.1	1.243	2	3.219
105.944	3	0.085	0.031	0.85	23.5	0.187	3	48.1	1.864	3	4.828
141.259	4	0.113	0.033	0.9	24.9	0.250	4	64.1	2.485	4	6.437
176.573	5	0.142	0.034	0.95	26.3	0.312	5	80.2	3.107	5	8.047
211.888	6	0.170	0.038	1.05	29.1	0.374	6	96.2	3.728	6	9.656
247.203	7	0.198	0.040	1.1	30.4	0.437	7	112.2	4.350	7	11.265
282.517	8	0.227	0.042	1.15	31.8	0.499	8	128.2	4.971	8	12.875
317.832	9	0.255	0.043	1.2	33.2	0.561	9	144.3	5.592	9	14.484

SP (Headquarters)

St Cross Business Park
Newport, Isle of Wight
United Kingdom PO30 5WU

T +44 (0) 1983 828000

F +44 (0) 1983 828100

E info@spsystems.com

SP (North America)

555 Boul. Poirier
Magog, QC
J1X 7L1

T +1 819 847 2182

F +1 819 847 2572

E info@spnorthamerica.com

SP (Australasia)

Unit 1A / 81 Bassett Street,
Mona Vale, 2103 NSW, Australia

T +61 (0) 2 9979 7248

F +61 (0) 2 9979 6378

E info@spoz.com.au

Cover photo credits:

First row - right: Courtesy of MG Rover,

Second row - Right: Courtesy of Vestas Wind Systems A/S

Third row - left: © Neil Rabinowitz

W www.spsystems.com